

# Radio-Sky Spectrograph Help

June 2022 – Radio-Sky Publishing

Radio-Sky Spectrograph (RSS) is a program for recording and reviewing radio frequency spectrograms. RSS records consecutive snapshots of the power in each of up to 512 frequency channels. Data can be shared in real time over the internet or saved to disk for review. This program will only run under Windows or a Windows emulator. For some background on the evolution of RSS see [History](#).

RSS relies on external hardware and intermediary programs to provide it with spectral data. The illustration below depicts the ways to feed RSS.

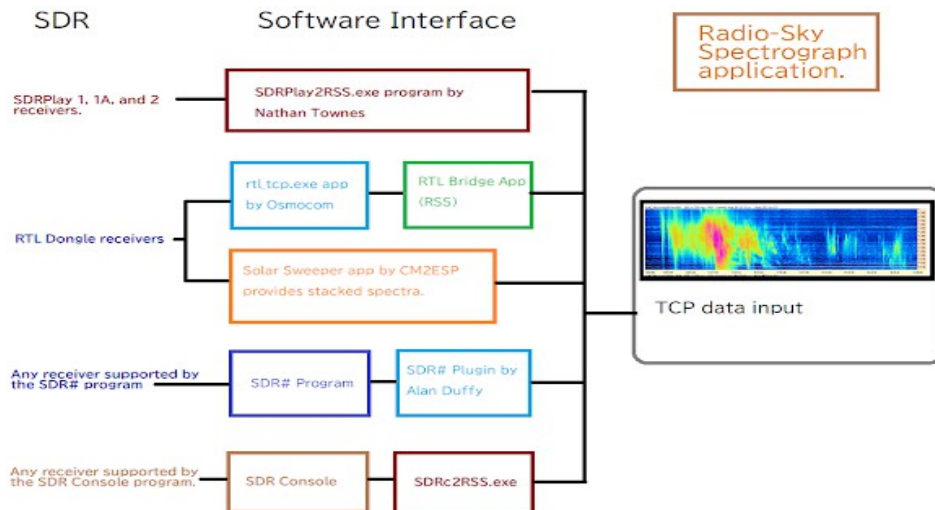

Note that a large number of different SDR receivers are supported through the work of Alan Duffy and his plugins for SDR# and SDR Console. RSS can also more directly control the FSX line of sweeping receivers from RF Associates and Rfspace's SDR-14 receiver but neither of these types of radios are still available.

You don't need a receiver to use RSS in client mode. Client Mode allows you to connect remotely with another person's live receiver data. When in Client Mode, usually you will see that there are at least a couple of available spectrum servers available for connection. Experiment with the color controls, save and load files, as you learn about the various display functions.

If you have questions not answered here, feel free to visit the radio-jove groups.io list for a community of advice. We will be there to help *but please look here first and familiarize yourself with the basic operation of the software*. There are lots of menus in this program and one of them may lead to a feature you want, so explore the program and the help documentation

## Menu Contents

[Installation and Running As Administrator](#)

[Spectrum Displays](#)

[Main Panel](#)

[Operating Modes](#)

[File Menu](#)

[Combining Files](#)

[Metadata](#)

[View Menu](#)

[Color Menu](#)

[Receiver Menu](#)

[Identity / Antenna Menu](#)

[Spectrogram Menu](#)

[Main Options](#)

[Network Options](#)

[SkyPipe Streaming](#)

[File Saving Options](#)

[Correction Files](#)

[Atomic Clock](#)

[Program Priority](#)

[Update Interval](#)

[Auto-start Server](#)

## Appendices

[History](#)

[Saving Images](#)

[Annotations](#)

[The Importance of Metadata](#)

[The Importance of Timing](#)

[SDRPLAY2RSS](#)

[RTL Bridge](#)

[Stacked RTL Spectrograms](#)

[RTL Observations](#)

[TCP Receiver Protocol](#)

[SPS Data Format](#)

[Using RSS with Radio-Jupiter Pro](#)

[Tuning an ICOM receiver.](#)

[Combining SPS Files](#)

[SPS File Recovery](#)

## Installation

Please install RSS in the default installation directory **C:\Program Files (x86) \Spectrograph\ if possible.**

RSS is known to work with American / UK /and many european regionalized computers. It may not work for some other languages and region settings. If after installing RSS, you suspect this may be an issue, you can temporarily change your Windows region/language setting to the US to test this possibility.

By default your data files will be saved in *My Documents\SpecData\*. This can be changed, however you must pick a location that has easy write permissions like under *My Documents* or *Public My Documents*. The latest versions of RSS extensively use a folder *My Documents \Radio-Sky \Radio-Sky Spectrograph* to store files that the user should have access to like configuration files. This folder should be kept separate from the data files folder, *My Documents\SpecData\*.

Important – RSS version 2.9.63 and newer automatically sets itself to Run As Administrator. If you are running an older version see: “[Setting RSS to Run as Administrator.](#)”

## The Spectrum Displays

Radio-Sky Spectrograph spectrum displays (Illustration 1) have three dimensions; time, frequency, and intensity. Frequency is scaled from high to low with the highest frequency at the top of the spectrogram. The spectrum scrolls from right to left with the most recent spectrum on the right. Intensity is represented by color. Color palettes can be used to enhance the portion of the power spectrum of interest.

HNRAO - 10/27/2020 - UTC - LWA Array - RCP - Correction file: Correction Array HNRAO 2017 01 31 FSX-2 LWA 15-30.csv

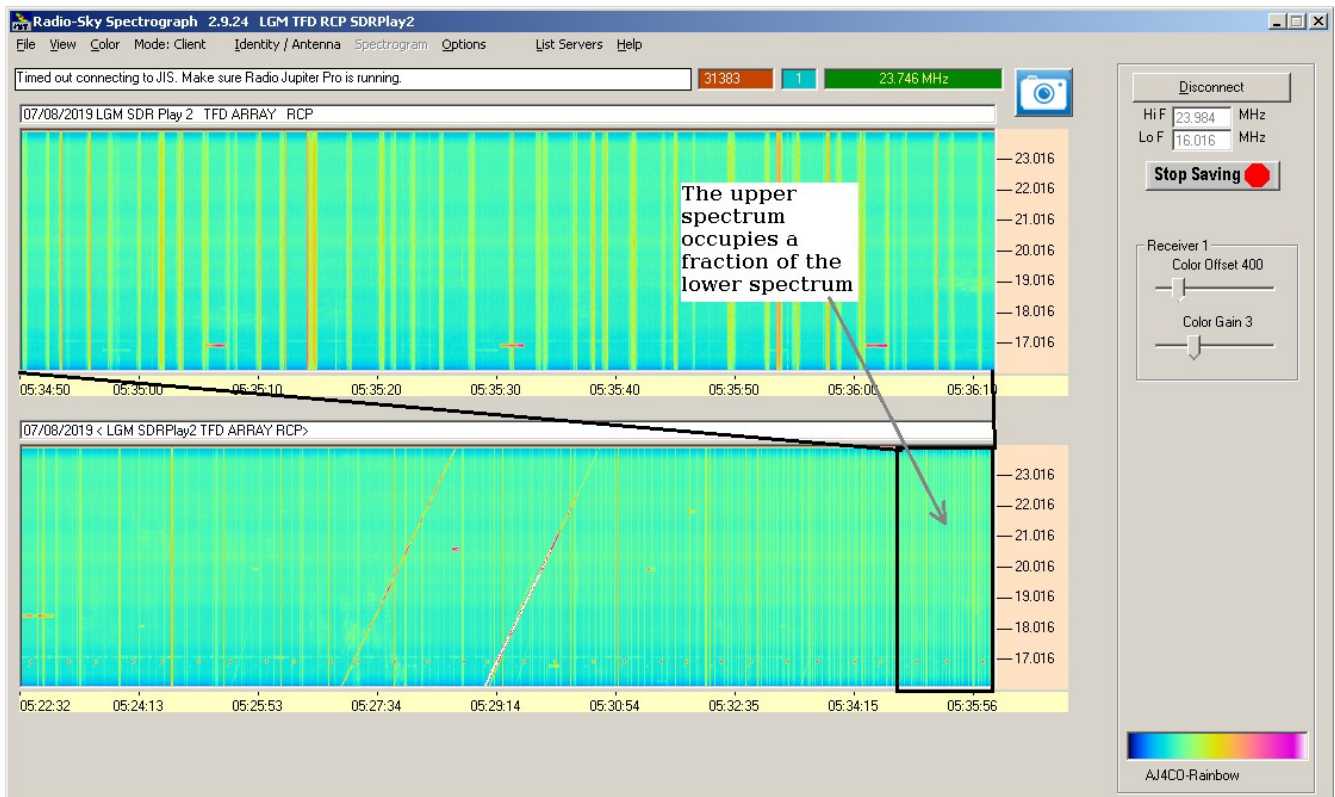
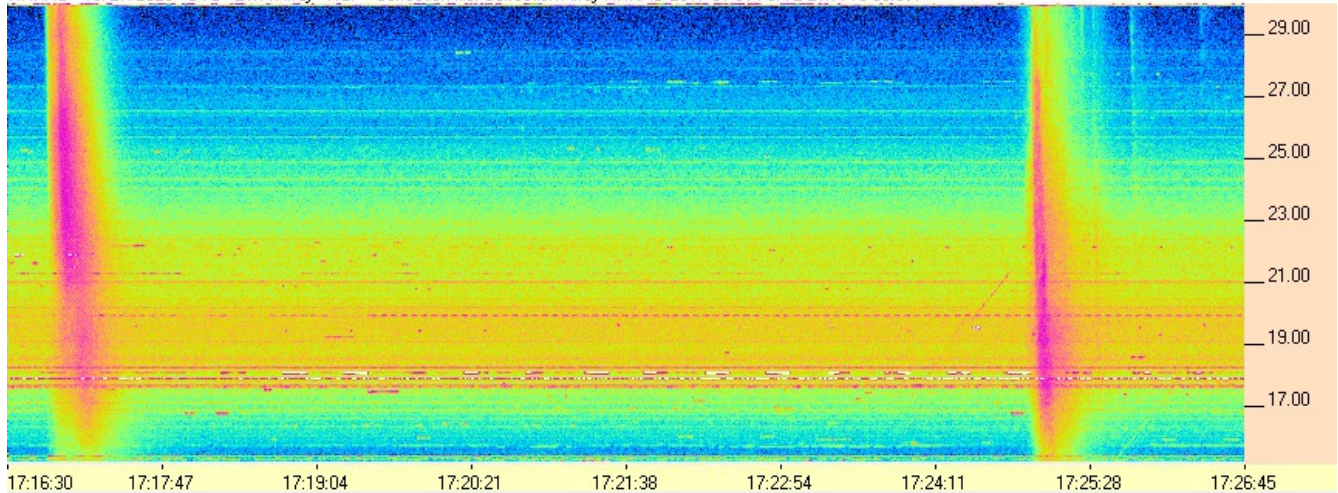

*Illustration 1: The RSS display shown in single receiver mode, where the live data is shown at two time resolutions. The data is averaged in the lower display.*

Early experiments suggested that it was useful to view the live data in RSS with two time resolutions. For example, 1 and 10 minute views gave a peek at the short-lived bursts in a Jupiter decametric storm as well as the trends of the storm. Is it increasing or decreasing emissions at some part of the spectrum?

By default, the bottom display is a time averaged version of the upper display. To set the number of incoming sweeps to be averaged go to **Spectrogram / Number of Spectra to Average**. If this number is set to 5 then the bottom display would have only one sweep displayed for every 5 in the top spectrum

display. It would also cover a 5 times longer time span.

While this is the default configuration for a single (non-switching) receiver, the second (lower) display can also be used to view the incoming data in a 2-D graph called the Scope View. To turn on the Scope View go to **View / Scope View** in the menu.

The two-spectrum display is also necessary when viewing both receivers/antennas in a dual receiver or switching type spectrograph. When used this way, you may still switch to Scope View or an averaged view, just not simultaneously with your not-averaged display. To switch to the averaged view just check the small checkbox labeled **Avg** at the lower right of the lower display. Deselect the checkbox to return to the not-averaged view. **Scope View** is obtained in the usual way by clicking **View / Scope View**.

### **Hiding the Bottom Display**

Having extolled it's abilities, I find the bottom chart area more often an annoying use of precious screen real estate. Pressing **CTRL+H** will hide or show the bottom chart. You can also do **View / Hide Bottom Display**.

## Main Panel

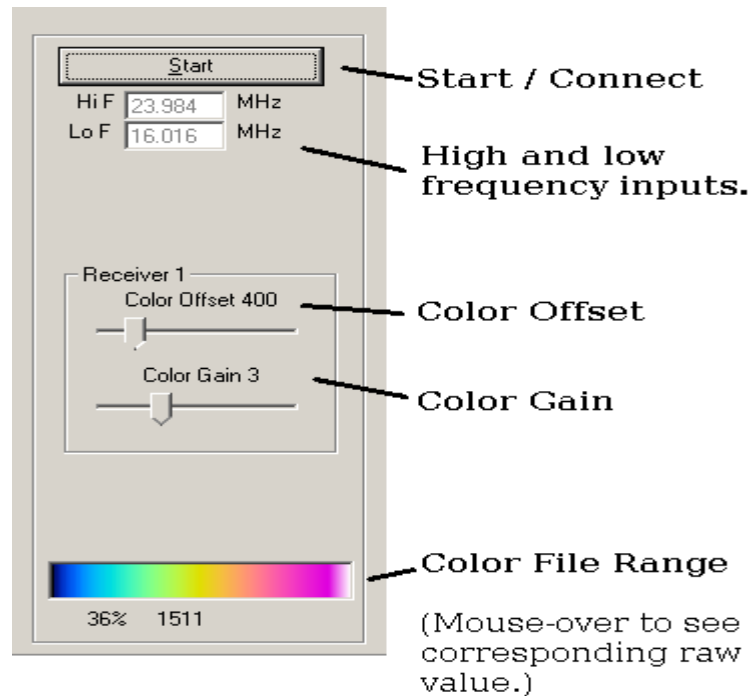

*Illustration 2: RSS main window controls. The Start button reads "Connect" when in Client Mode. When two receivers are used, separate color controls will be displayed for each along with option to link them.*

The **HiF** and **LoF** text boxes hold the high and low frequency limits of the spectrum, respectively. Receivers that connect via the TCP protocol to RSS, dictate these values to RSS just before the observation starts. For other receivers like the SDR-14, you must enter the frequencies into these RSS text boxes manually.

**Color Offset** subtracts the given value from the spectral data before it is displayed. In essence, it allows you to remove some of the background signal. You can then increase the range of colors displayed by applying a **Color Gain** control that multiplies the data by the selected factor. You may use the associated slider controls or *Right Click* the control to enter the value in a text box. Note that on the **Color Gain** control, values below one actually decrease the color variance.

## File Menu

The File Menu deals primarily with loading and saving data and images. The 3 *Run* options provide ways to automatically start and stop observations.

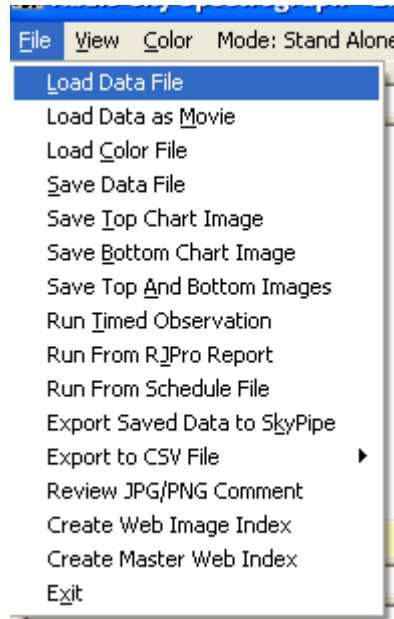

*Illustration 3: File Menu subitems.*

**Load Data File** – Browse to a data directory and open a SPS data file for review. If the data file was interrupted while it was being collected, a SPS file might not be present. In that case you can likely recover the data from the temporary SPT file and it's associated SPH header file. See [SPS File Recovery](#).

**Load Data File as Movie** – opens the data file as stream of incoming spectral samples, simulating real-time observation. When opening a file this way you may control the display speed (1-10) using the right and left arrow keys. Pause the stream using the *P* key and stop the stream using the *Escape* key.

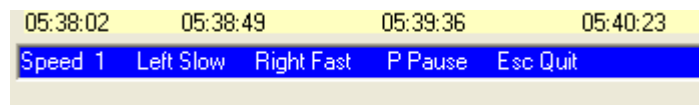

**Save Data File** – manually save a SPS file to the drive. The SPS file format is composed of a header with mixed text and binary components followed by spectrograms expressed as two byte integers. A more detailed description of the [format can be found here](#).

The next three menu items deal with saving an image of the current spectral display. In addition to these menus under the File menu heading, there is also a camera button on the top right of the main window that will trigger these actions, as will double clicking on the spectrum. For more information

about saving images see “Saving Images in RSS”.

**Save Top Chart Image** – Saves a BMP, JPG, or PNG image file of the top chart.

**Save Bottom Chart Image** – Saves a BMP, JPG, or PNG image file of the bottom chart.

**Save Top and Bottom Chart Images** – Saves both charts as a single image in BMP, JPG, or PNG format. Note: selection of the image format is made under **Options / File Saving / Picture Format**.

**Run Timed Observation** – Allows you to run an unattended observation of limited duration at a specified time. You must complete the form shown below to use this feature. If you check the **Run Schedule Every Day** box then the schedule will repeat. By pressing *CTRL+Z* a reasonable, (almost) 24 hour operation schedule will be populated into the times. More complex yet useful scheduling methods are available in the next two menu items.

Start			End		
Day	Month	Year	Day	Month	Year
2	6	2022	2	6	2022
Hour	Minute	Seconds	Hour	Minute	Seconds
5	21	18	6	21	18

Run Schedule Every Day?

OK Cancel

ctrl+z for 24 hr

**Run from RJPro Report<sup>1</sup>** – This option is specialized for Jupiter decametric observations. It allows you to use a report file from [Radio-Jupiter Pro](#) (RJPro) software to automatically observe at the times of highest probability. To use this option you must first create the RJPro report file from within RJPro. . This is a human readable file that RSS can parse into a observation schedule. The illustration below shows you the procedure. Once the report has been saved in RJPro you are free to close that program. After loading the report into RSS, click the **Press to Activate** button.

<sup>1</sup> This feature was written at a time before Terabyte hard drives were common and inexpensive. Today, it makes more sense for most observers to just run continuously, stopping once or twice a day to begin a new file.



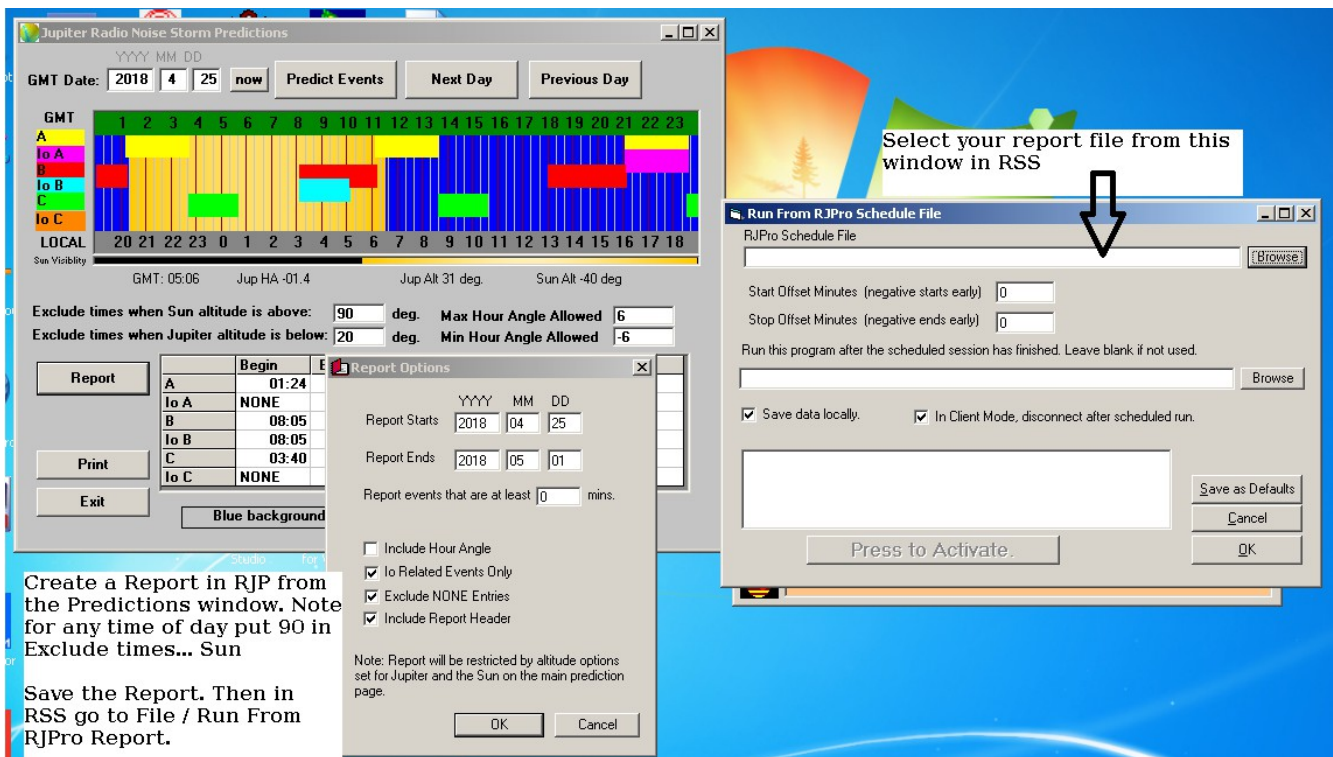
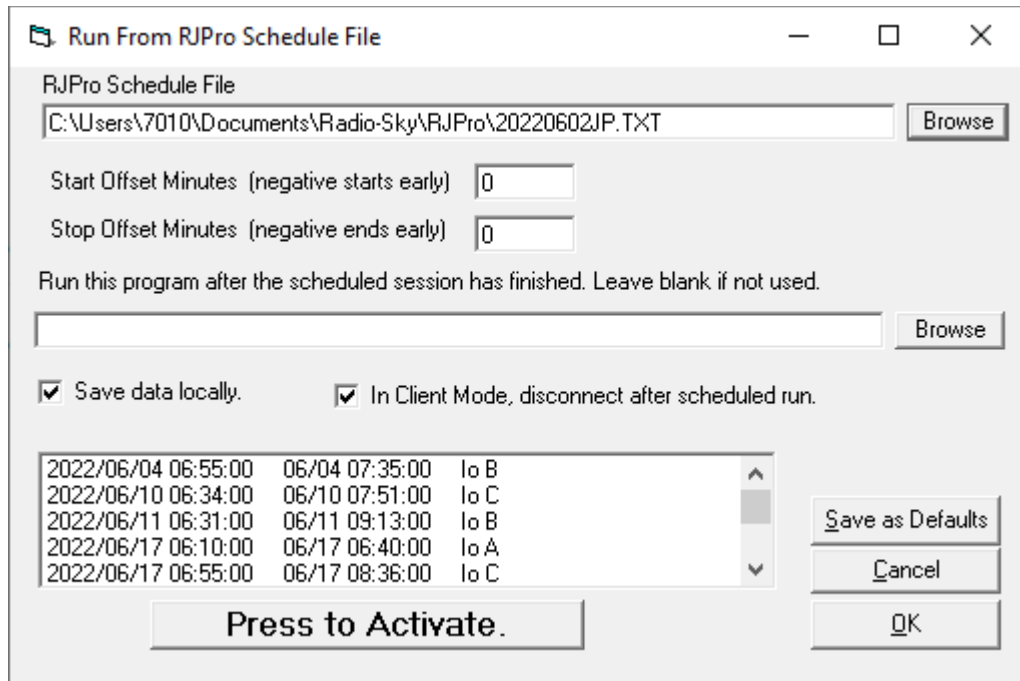

Illustration 4: Left Side: The configuration windows used in Radio Jupiter Pro when creating a schedule file to use within RSS. First open a Prediction window and create a report using options as shown. Right Side: From RSS do File / Run From Schedule File, then navigate to the report you just created.

**Run from Schedule File** – Allows you control several RSS parameters and run times based upon a text file that you can write with any text editor. A typical file is shown below (comments shown in green)

are not part of the file.):

```

daily
start=02:03:00; Start time.
channels=300; Number of channels
offset=175; Color offset
colorgain=1.0; Color gain
LOF=22000000; Lowest frequency in Hz
HIF=26000000; Highest frequency in Hz
stop=06:05:00; Stop time
start=23:59:00;
channels=200;
offset=100;
colorgain=1.5;
LOF=18000000;
HIF=28000000;
stop=01:01:00;

```

If the schedule is to be repeated each day then the file should start with the line “*daily*”. This example schedule shows two separate observations, each at a different freq range, color gain, color offset, and number of channels. Schedule files are simple text files stored in the application directory with the extension skd. The schedule is implemented as soon as the file is selected. Pressing the Escape key will cancel a schedule,

**Export Saved Data to SkyPipe** – This option allows you to export the raw (not offset or otherwise processed) data from up to 8 individual channels to the Radio-SkyPipe. You can obtain the free one channel version of Radio-SkyPipe software at <http://radiosky.com/skypipeishere.html>. A file must be loaded from the disk before this operation will work. When selected, you will receive the following form:

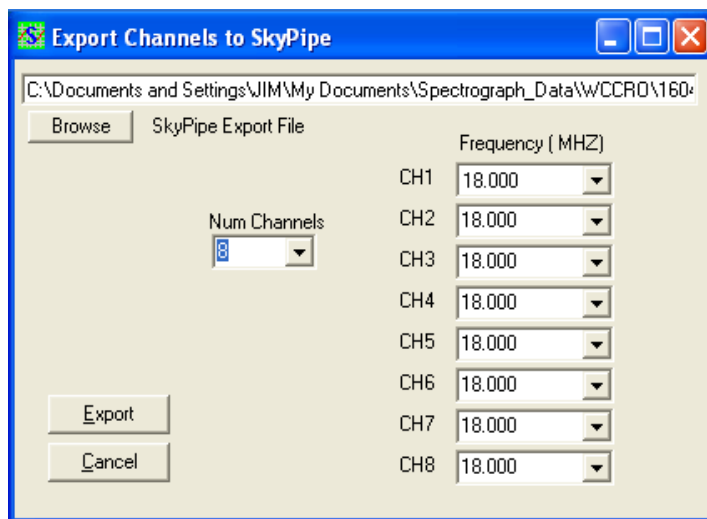

Select the number of channels to export and then the frequency for each channel. After clicking Export the Radio-SkyPipe readable (SPD) file is created.

**Export to CSV File** (entire file or current view) – This function requires that a file be loaded from disk. Select either the **Export All** or **Export View**. Export View extracts the visible portion of the data and not the entire file. After selecting the file, you are prompted with:

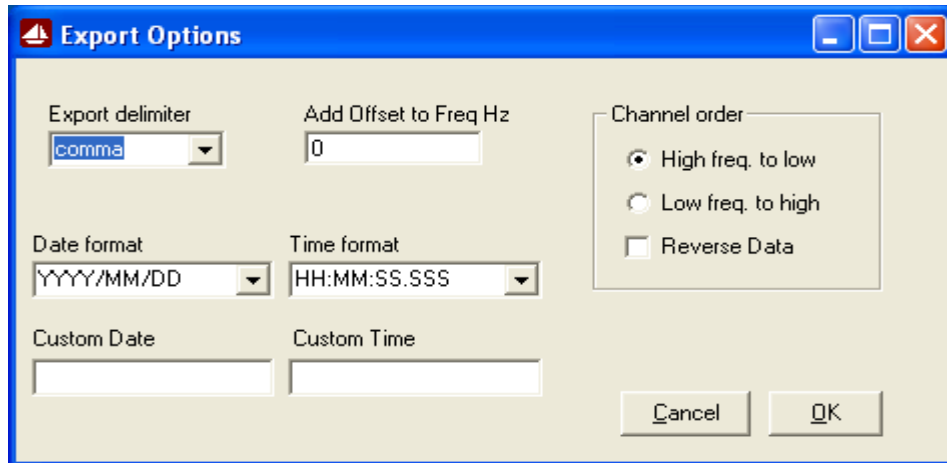

If you want to use a different field delimiter than the comma, select it from the Export delimiter drop down menu. The exported file records will have the date and time followed by the value recorded for each frequency. Use **Channel order** reverse the frequency order. The **Reverse Data** check box keeps the frequency column values in the specified order but reverses the data order, effectively inverting the spectrum. Why would you want to do this? This is useful for situations where the data has been down-converted from another frequency using a reversing mixer scheme.



*Illustration 5: RSS saves essential metadata within JPG and PNG files.*

**Review JPG/PNG Comments** – Allows you to see the metadata that RSS places in all of the JPG and PNG image files saved within the program. See Illustration 5. Also see “[Saving Images in RSS](#)”.

**Exit** – Terminates RSS in an orderly fashion.

***End of Section***

AJ4CO Observatory 16 Apr 2020 - DPS on TFD Array - RCP - Correction Array 2017 01 10.csv - Offset 2100 Gain 5.0

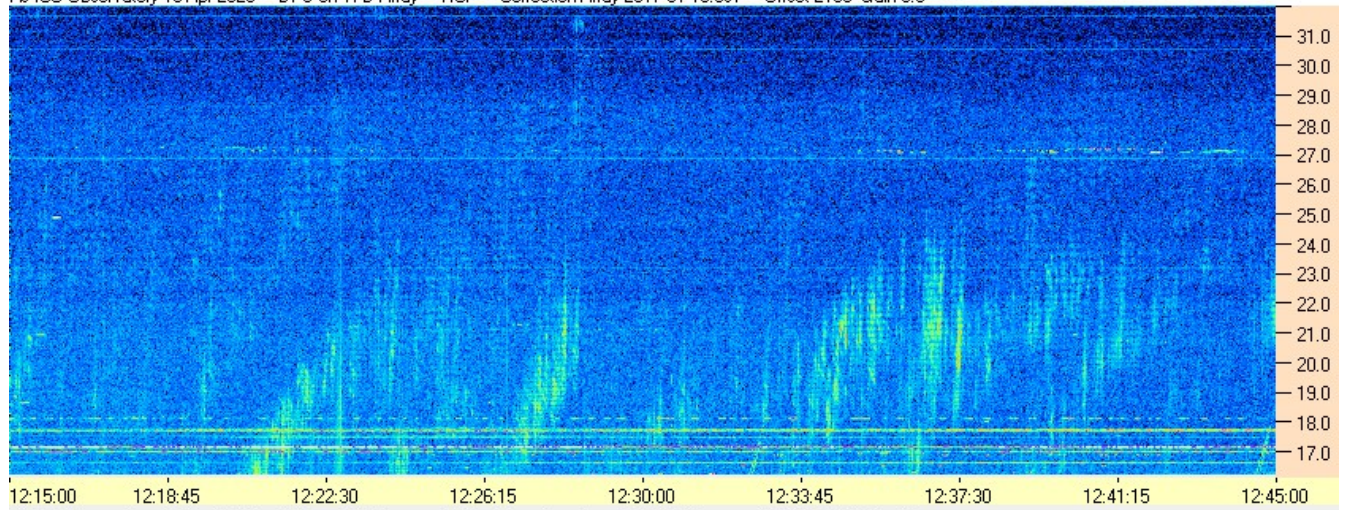

AJ4CO Observatory 16 Apr 2020 - DPS on TFD Array - LCP - Correction Array 2017 01 10.csv - Offset 2100 Gain 5.0

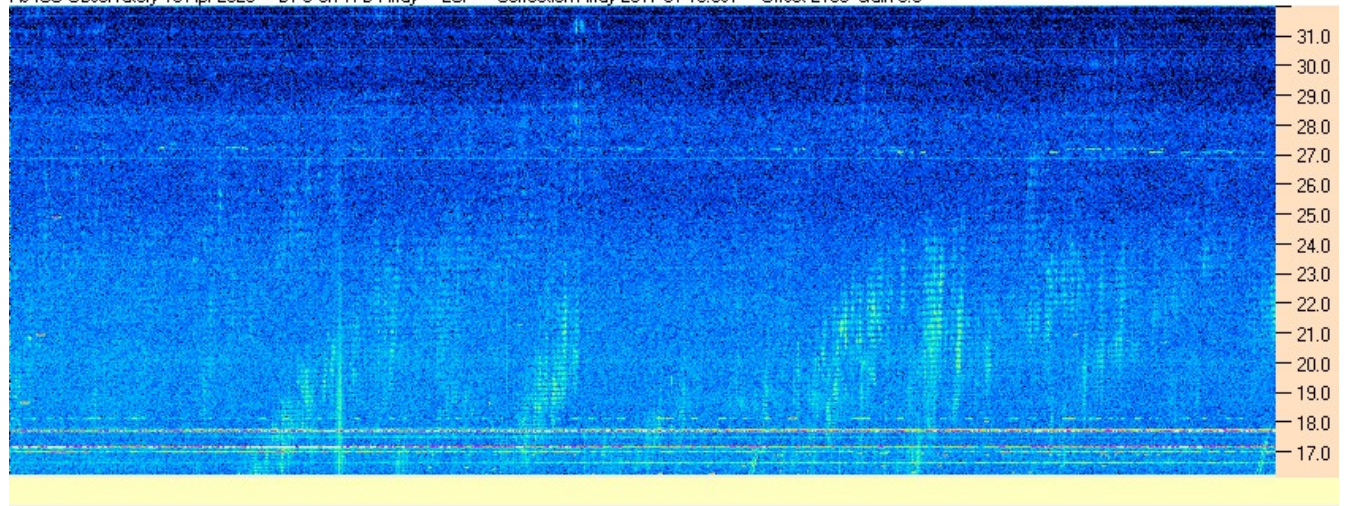

*Illustration 6: AJ4CO's dual polarization spectrograph (DPS) simultaneously examines Jupiter emissions in right and left hand circular polarizations.*

## View Menu

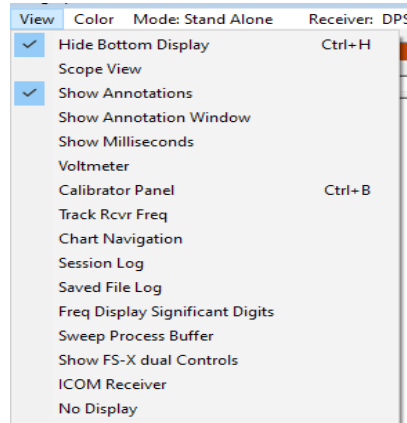

*Illustration 7: View Menu sub-items.*

**Hide Bottom Display** – Spectrograms with many channels can consume a lot of screen area. You can toggle the visibility of the lower spectrogram using this menu item or its CTRL+H shortcut.

**Scope View** - displays the incoming spectra in a 2-D format. When selected, the lower view converts to a display like the one shown below (Illustration 7)

**Show Annotations** – Toggles the visibility of annotations contained in the spectrogram.

**Show Annotation Window**- See [Annotations appendix](#)

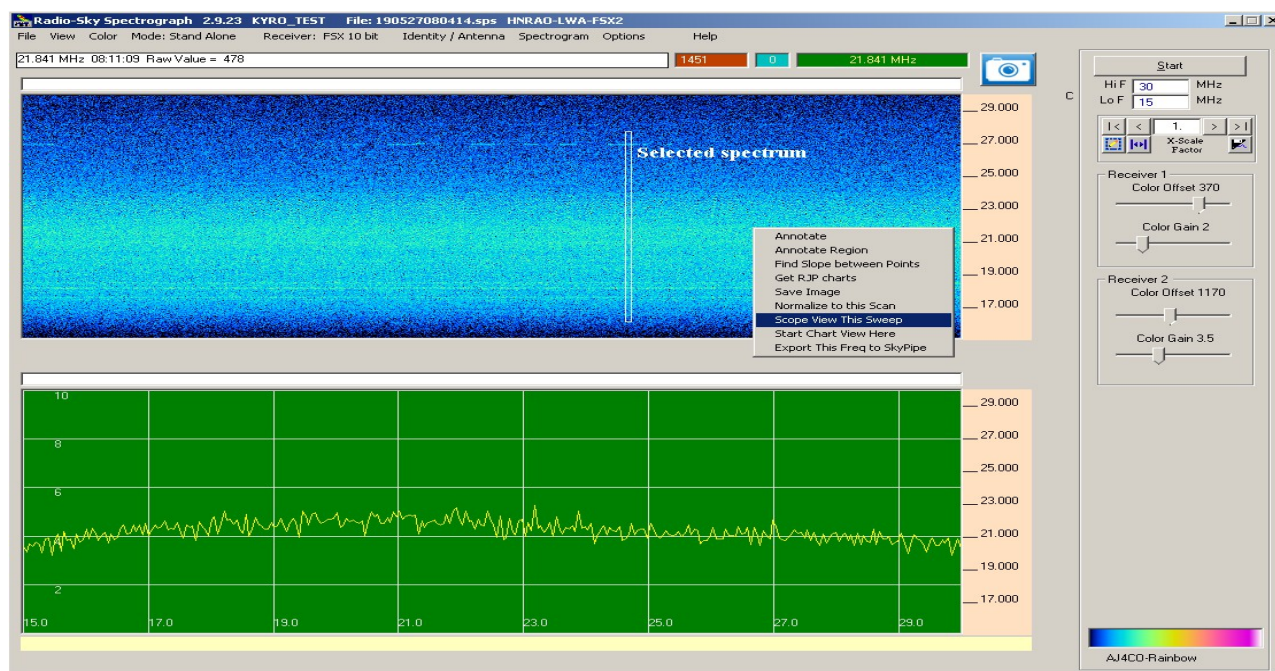

*Illustration 8: The Scope View displays the spectrum in a format analogous to a traditional spectrum analyzer.*

*The vertical scale is the signal normalized to the maximum value as set by the resolution of the receiver ADC, so a 10 or 12 bit ADC will have their corresponding maximums (1024 or 4096) normalized to 10. The horizontal axis is frequency. When using a dual or switching receiver both the top and bottom displays will show the Scope View, giving a display for each receiver. To see this display in a loaded file, right-click on the sweep you want and select “Scope View This Sweep”.*

**Show Milliseconds** – Display milliseconds in the time bars. This is useful for displaying high speed spectrograms.

**Volt Meter** – Displays a window with the voltage supplied to the ADC in a [FSX style receiver](#). Useful for troubleshooting and testing.

**Calibrator Panel** –Opens the Calibrator Panel which is used to manage the MK2 calibrator.

**Track Receiver Frequency** - displays an arrow on the upper chart corresponding to the ICOM receiver frequency when one is used.

**Chart Navigation** – Displays a small control panel for navigating around a spectrogram loaded from file. These controls are not available during a live observation.

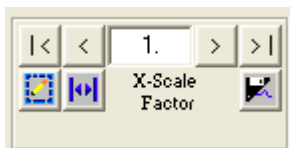

The controls are quite simple. The |< and >| buttons take you to the ends of the chart. The > and < buttons advance one screen of data. The amount of data displayed on a single screen is controlled by the X-scale factor. If set to 2 for example, each sweep would become an average of 2 sweeps.

The pencil icon button on the lower left allows you to enter specific time coordinates that you want to view. Next to it is the **Full View** button. When you select Full View for an observation, the entire file is iterated through, averaging adjacent sweeps, until the entire observation fits on a single screen. This can take several seconds depending on the size of the data file. The most recent versions of RSS save a copy of the full view image the first time it is created. Subsequent pushes of the Full View button reload this image without re-calculating the averages and thus is much faster. . You may want to set your Spectrogram / Number of Displayed Spectra to 1200 to see the maximum amount of detail.

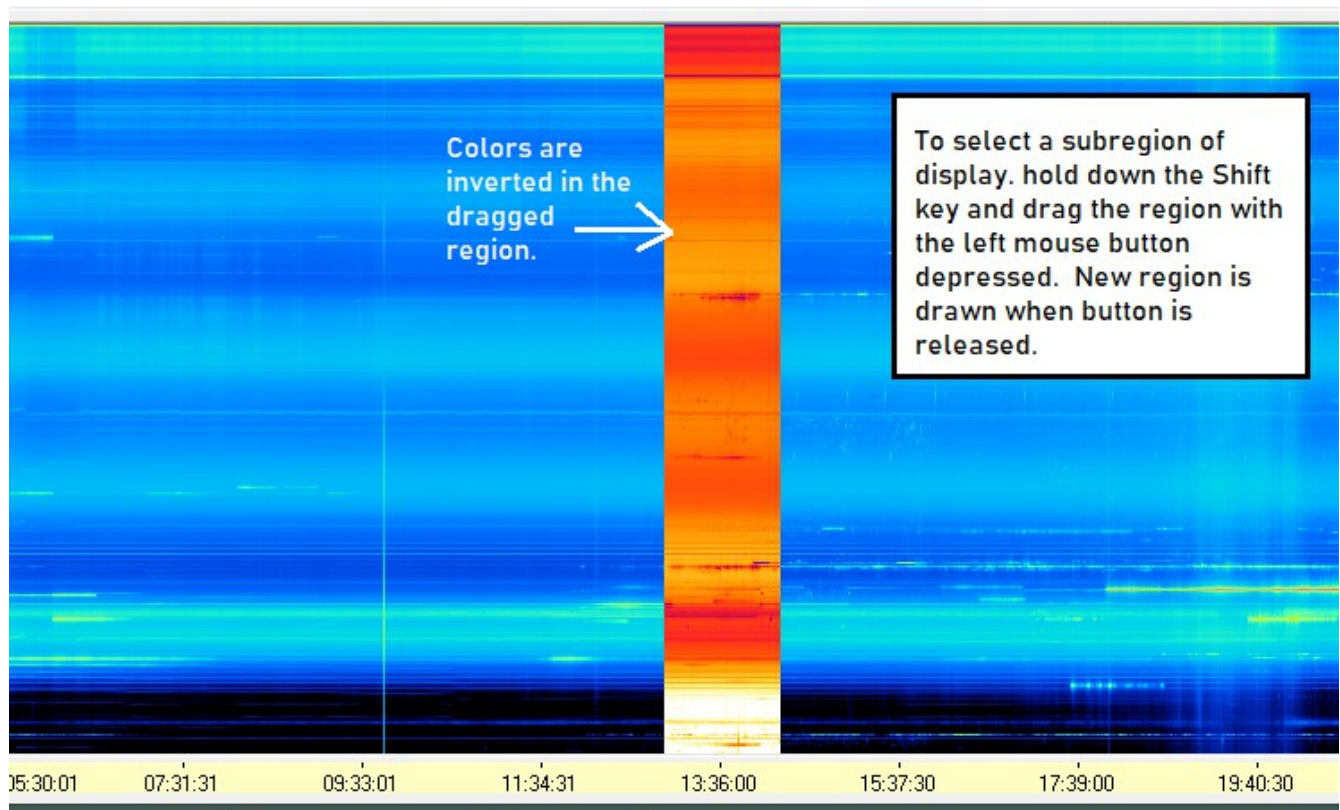
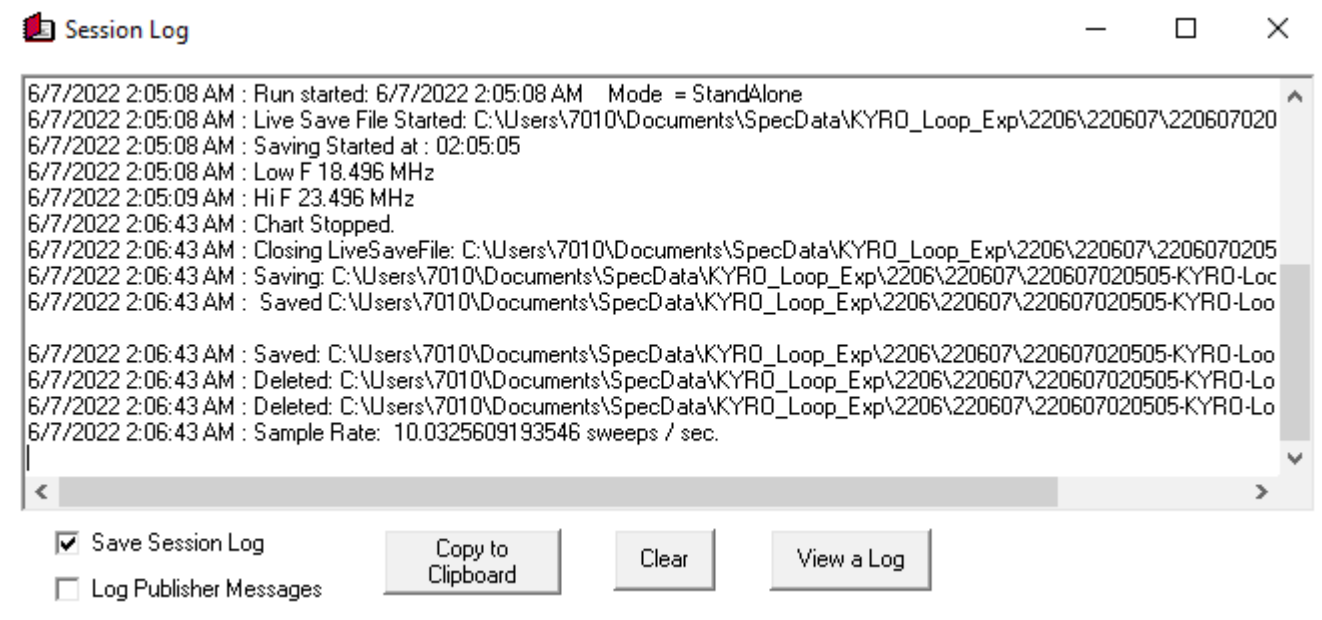

*Illustration 9: Selecting a sub-region of the displayed full view image is done by depressing the Shift key and dragging the desired region.*

Finally, on the lower right is a **Save View** button which allows you to save the visible portion of the file, effectively a way to take snippets from a large file.

**Session Log** – Shows the session Log window which records many of the processes and events in RSS.





*Illustration 10: The session log can be very helpful in diagnosing problems. A button is provided to copy the text to the computer clipboard.*

Saving the Session Log automatically is highly recommended. Only Log Publisher Messages if you are having troubles with internet related operations.

**Saved Log File** – Opens the log of all files saved by RSS. Logging must be turned on under **Options / File Saving / Log saved Files**.

**Frequency Display Digits** – Determines the resolution of the frequency markers on the vertical scale.

**Sweep Process Buffer** – Displays the number of sweeps currently in the buffer to be displayed. This is useful for determining if RSS is keeping up with the rate of incoming data.

**Show XXXX Controls** – Displays a small control panel used for testing FSX receivers and optioning other types of receivers. Some receivers do not have this option available..

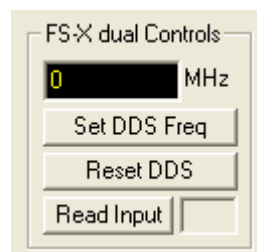
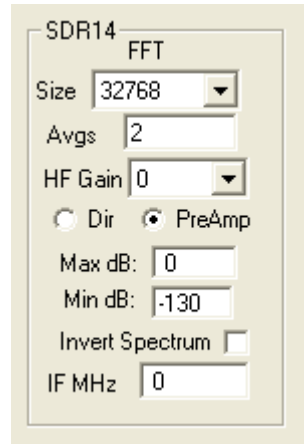

*Illustration 11:  
FSX Control Panel.*

This is an example of an FSX control panel (Illustration 9). You will probably never use this, but there is one handy button, **Read Input**, that tests for a communication link with the FSX receiver. It returns "ON" or "?" to indicate success or a timeout respectively when querying the PIC micro-controller over

the serial connection.

The **SDR-14** interface is more useful and has several options for the SDR-14.



*Illustration 12: SDR-14 Control Panel.*

The configuration controls for the SDR-14 accommodate use as the IF of a down-converter. Note the **Invert Spectrum** and **IF MHz** options. These should remain blank for normal operation. There is access to spectrum size but the number of channels shown by RSS is set under the Spectrograph menu. This result will be an average of the FFT size bins condensed into the number of channels specified in RSS.

**ICOM Receiver** – If you have an R8500 or R75 ICOM receiver connected to the computer via a serial cable, you can use the RSS spectral display to tune the receiver to monitor the demodulated signal on any frequency channel in the spectrum. This option displays a ICOM receiver window that allows you to send commands to the receiver via a serial connection. [Read more about this here.](#)

**No Display** - turns on/off the display. May be useful for collecting data on a PC with marginal resources as the display tends to use considerable CPU cycles.

## MetaData

When a file is loaded or data is being collected the Metadata menu item will appear on the menu bar. Metadata is information about the file that gives it context and describes it's qualities. See [The Importance of Metadata](#). When you click the Metadata menu item, you receive an editable window of the major metadata fields that are passed in the file.

	Year	Mo	Day	Hour	Minute	Second		
Start	2020	12	04	07	22	12		
Finish	2020	12	04	10	34	27		
Version:	0000209031			High Freq:	24004000			
Author:	Larry Dodd			Low Freq:	15996000			
Observatory:	K4LED-TFD-RSP			Channels:	411	<b>Single</b>		
Latitude:	34.423239			Number of Sweeps:	76895			
Longitude:	-84.494122			Duration:	03:12:15.339			
Location:	Jasper GA			Rate:	6.666037	sweeps/sec		
Receiver:	SDRPlay							
Notes:	<div style="border: 1px solid gray; padding: 5px; min-height: 50px;">           Data received in client mode. May not be suitable for archiving.         </div>							<div style="text-align: right;"> <input type="button" value="Template"/>  <input type="button" value="Edit"/>  <input type="button" value="OK"/>  <input type="button" value="Cancel"/> </div>
Banner Top	<div style="border: 1px solid gray; padding: 2px;">           K4LED Observatory, &lt;DATE.&gt; SDRplay2PRO on 4TFD Array, RHC polarization, Jasper GA USA 30143         </div>							
Banner Bottom	<div style="border: 1px solid gray; padding: 2px;">           K4LED Observatory, &lt;DATE.&gt; SDRplay2PRO on 4TFD Array, RHC polarization, Jasper GA USA 30143         </div>							

Most of the metadata fields are self-explanatory or are covered by other topics in this document. You should be very careful when editing metadata fields. Some of the fields like the start and stop times, the number of sweeps and rate fields are interdependent. Changing the **Receiver** could cause the data to be misread. It is perfectly permissible to change the **Notes** and **Banner** fields. The **Antenna** parameters are also safe. You might find for instance that you had forgotten to change the beam elevation metadata when you re-phased the antenna. To keep that from happening a second time, be sure to click the [Antenna \ Identity](#) menu and change the value in your observatory profile.

The **Template** button is useful if you have the data from an dot SPT file but no associated header file (SPH extension). See [Recovering SPS Files](#).

## Color Menu

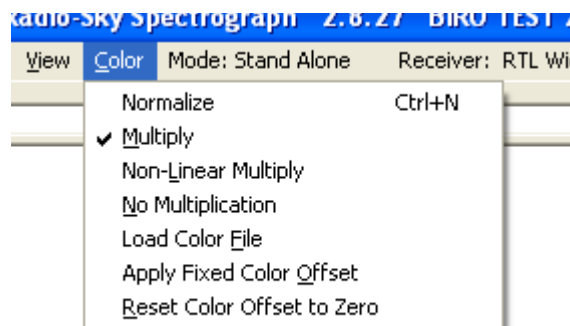

*Illustration 13: Color menu subitems, control the color mapping of RSS.*

The data received by RSS is preserved unmodified in the data files. However, you have the option of mapping the intensity values of the data to a number of different color schemes to allow you to better visualize the intensity variations. As of 2019, RSS is limited to 12 bit data. Thus the color mapping is limited to 4096 possible colors, and these are palettes stored as a series of RGB values in a *color file*. Each RGB value is composed of a color value ranging from 0 to 255 with green (G) value multiplied by 256 and the blue (B) value multiplied by 65536 so that  $RGB = R + G * 256 + B * 65536$ .

**Normalize** – Uses the last group of averaged sweeps to produce individual offsets for each channel. Normalize is not compatible with Apply Fixed Color Offset which adds the same offset across all channels. Use the Normalize option to remove strong constant signals from the spectrum visualization.

**Multiply** – applies a multiplier, the Color Gain, to the data color mapping, effectively exaggerating small differences in signal level at the expense of dynamic range.

**Non-Linear Multiply** – This option applies a simple function that will increase the color changes seen at lower signal levels.

**No Multiplication** - turns off multiplication in color mapping.

**Load Color File** – Loads a file of the RGB values used in color mapping the spectrum. While it is sometimes possible to load a color file while collecting data, it may cause an interruption in the data stream and is not suggested.

**Apply Fixed Color Offset** – Manually apply a offset for color mapping. You may also use the Color Offset slider control on the [Main Panel](#) to accomplish this task.

**Reset Color Offset to Zero** - Fast way to reset the color offset after you have normalized the display. You may also use the Color Offset slider control on the [Main Panel](#) to accomplish this task.

## Operating Modes

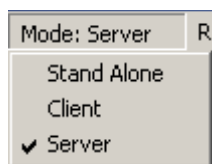
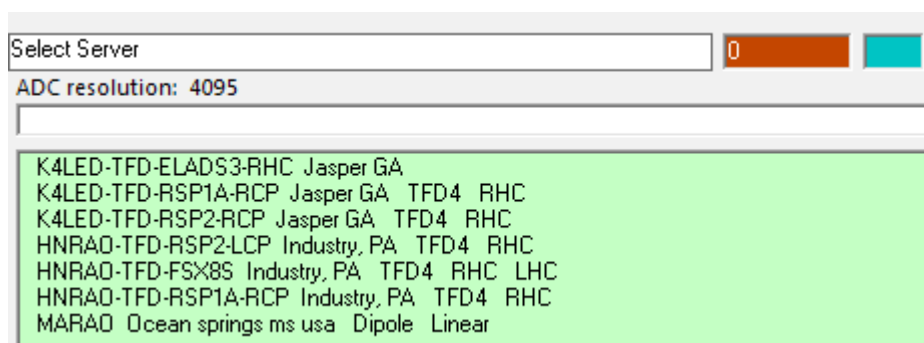

*Illustration 14:  
Operating  
Modes menu.*

(RSS uses the same operating modes as [Radio-SkyPipe](#)):

**Stand Alone Mode** assumes you have a receiver (live data input) or are reading RSS data files from a directory on your computer. In Stand Alone Mode your data is not available for others to see live on the internet. It is the mode you will use to view, edit, or export saved data files.

**Client Mode** allows you to connect to others who are active as servers. After selecting Client Mode you will see a list displayed as shown below (Illustration 13). It is possible that no servers will be listed at any given time but usually there are several. Double click a server to attempt a connection. You may refresh the server list by clicking the *List Servers* menu item at the top.



Note that just because a server is listed, it is not certain that you will be able to make a connection. In order for someone to share out their RSS data, they must have properly configured their router to allow connection requests to the RSS server. See [Network Configuration](#). The computer's own internal firewall also has to be configured to allow the connection.

Client Mode can also be used to monitor RSS data streams on your own local area network.

**Server Mode** allows you to share your live spectral observations over the internet. Of course, you do need a receiver to use this mode. There are some items you must configure to be a server. You need to configure the **Local Connection** and set up Port Forwarding on your internet router. Any firewall must be configured to allow outside connections to the PC that are directed at RSS. See [Server Network Configuration](#).

## Receiver Menu

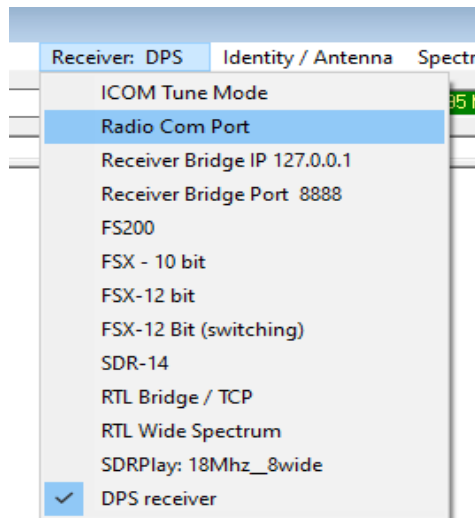

*Illustration 15: The Receiver Menu allows for selection of receiver hardware.*

The receiver menu allows selection of one of the supported receivers for **Stand Alone** or **Server** mode operation. This list may change as more receivers are added.

**ICOM Tune Mode** – is a feature that allows some ICOM receivers to automatically switch to a frequency pointed to on a live spectrogram. The feature is known to work with ICOM R-75 ICOM 8500 This feature allows the user to listen to the detected audio concurrent with visual features appear on that frequency. [More information here](#).

**Radio Com Port** - If the selected receiver uses a serial (com) port the port number is selected here.

**Receiver Bridge IP** – When connecting to the receiver through a network TCP connection, such as one of the RTL receiver options, or using the SDR# plugin. “127.0.0.1” is the loopback address that computers use for communications between applications.

**Receiver Bridge Port** – The port number to use with TCP connected receivers (see above).

The [FS200](#), [FSX receivers](#), and the **DPS** receiver are all custom built receivers by RF Associates and are not available for purchase.

The **SDR-14** DSP receiver by [RFSpace](#) is no longer produced, but is sometimes available on the used market. It is a direct sampling receiver that can cover the entire HF band.

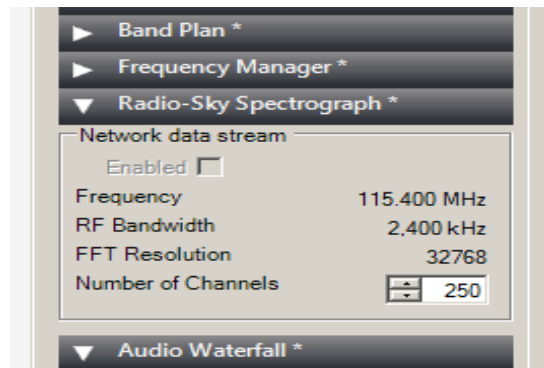

*Illustration 16: The Radio-Sky Spectrograph plugin written by Alan Duffy allows using any of the SDR# supported receivers with RSS.*

**RTL Bridge /TCP** – This option allows connection to RTL dongle receivers using the [RTL Bridge](#) program that accompanies RSS. In addition, this connection allows any receiver or software to send spectral data over a TCP connection using a specific format. For example, SDR# supported receivers can send spectral data to RSS using a SDR# plugin written by Alan Duffy (Illustration 15). This allows use of the excellent [AirSpy](#) receiver with RSS. Alan has also written a interface to SDR Console.

**RTL Wide Spectrum** uses a single inexpensive RTL dongle type receiver to cover 7, 15, or 30 MHz spans by stacking the 2 MHz wide spectra that are measured consecutively. When this receiver is selected, a **Configure RTLW** button will appear that opens a settings window for the receiver options. Information on this configuration can be found here.

<http://cygnusa.blogspot.com/2015/09/rtl-wide-spectrum-update.html>

**SDRPlay** – Use this option to use an [SDRPlay](#) 1A or SDRPlay 2 as your receiver. At the time of this writing, December 2021, only the RSP1, 1A, and RSP2 receivers are officially supported. These SDRPlay receivers are supported by the SDRPLAY2RSS application which works as an intermediary between the SDRPlay receiver and RSS. You may also connect to an SDRPlay receiver (or most any other common SDR) through use of SDRc2RSS and the SDR Console program.



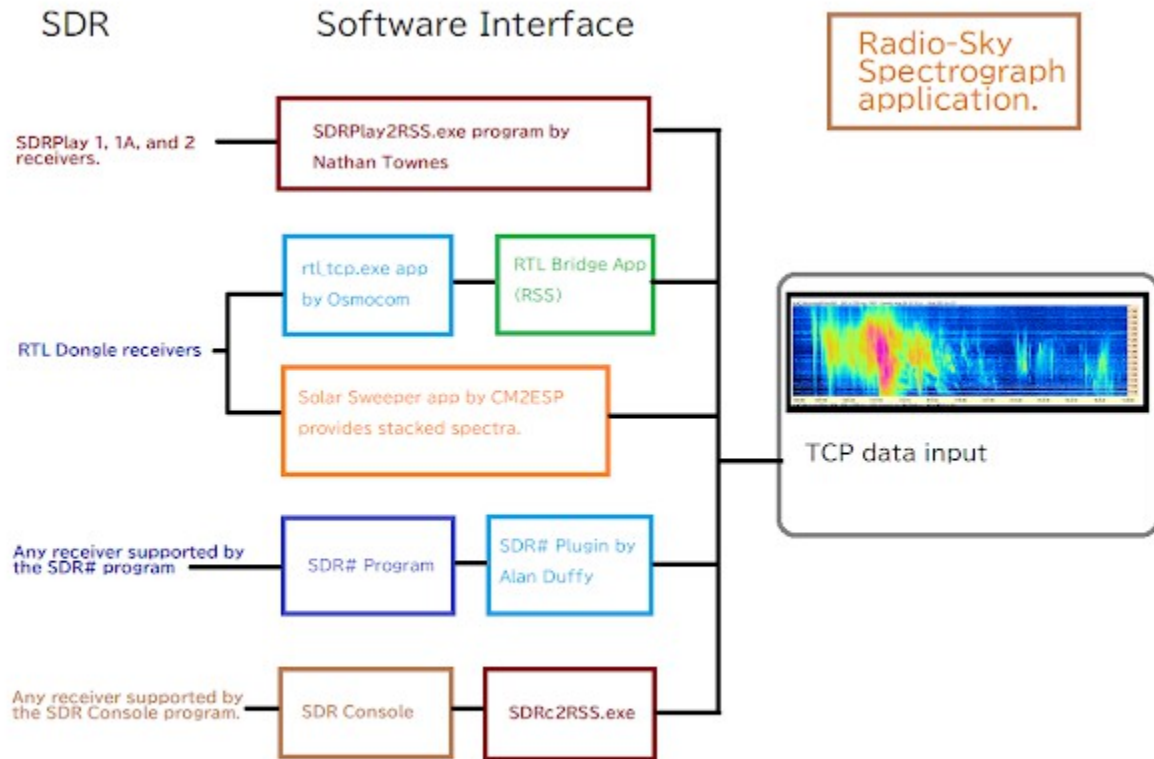

Illustration 17: Diagram of SDR to Radio-Sky Spectrograph interfaces.

## Identity / Antenna

Drop down list of antennas.  
Edit Antennas.txt or type in  
your description here.

Observatory  
KYRO\_TEST

Observer  
Jim Sky

Latitude  
38

Longitude  
85

Location  
Louisville

Time Zone  
-4  Auto Detect

Edit Free-Form Notes

Antenna

Description  
Window up 20'

Beam Azimuth  
180

Beam Elevation  
90

Polarization 1  
LHC

Polarization 2  
RHC

Published Caption  
<LOC> <ANT> <POL1> <POL2>

Enter a string here that will appear in the available servers list when you serve.

Apply and Exit Cancel

Az 0-359.9 deg.  
0 = North  
EL 0-90 deg.

Linear, LHC,  
RHC

If only one  
receiver then  
ignore Pol 2

*Illustration 18: The Antenna / Identity window is where you enter important metadata regarding your observatory.*

*Metadata* is the collection of important facts pertinent to our sample data. This menu option provides a place for metadata as was conceived as important to the Radio Jove Project. If you are using RSS to support this effort then entering in this metadata is essential if your observations are to be included with other observations. It is exceedingly important to remember to change any information regarding the antenna configuration.

### Observatory

Limited to 20 characters, this field contains the name of the observatory. Usually this is just an acronym, for example; Big Island Radio Observatory is BIRO.

### Observer

The name of the human managing the observation.

**Latitude**

Geographical latitude in decimal degrees. Southern latitudes are negative.

**Longitude**

Geographical longitude of the observatory. West longitude is negative.

**Location**

Limited to 20 characters, a short description of the location. Example; Memphis TN.

**Time Zone**

All data should be collected using Universal Time (UT). Just use the **Auto Detect** check box to determine the **Time Zone** which is the number of hours difference between UT and the local time.

**Edit Free Form Notes**

Every SPS file header has a area for the inclusion of free form text. This is a great place to put anything you want about your observatory or a given observation. For example, one observer placed the temperature levels of their calibrator, allowing future extraction of antenna temperature from the raw data.

**Published Caption**

This item determines how your observatory appears in the published servers list. You can use the <tags> shown in *Illustration 16* to automatically represent your important parameters so others can identify your observatory and telescope from the list.

***Antenna Metadata*****Description**

Select an antenna from the predefined drop-down list if possible, otherwise enter a short description of your antenna. By using predefined antenna descriptions you may make your observations more search-able.

**Beam Azimuth**

The approximate azimuth in degrees of your main antenna beam.

**Beam Elevation**

The approximate elevation in degrees above the horizon of your main antenna beam.

**Polarization 1**

Select one of the listed polarizations describing the antenna used in the upper chart.

**Polarization 2**

Select one of the listed polarizations describing the antenna used in the lower chart.

## Spectrogram

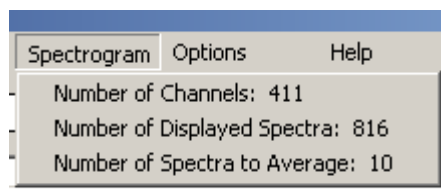

*Illustration 19: The Spectrogram menu sets important general characteristics of the spectrogram presentation.*

### Number of Channels:

Number of individual frequency channels. There is a minimum of 50 and a maximum of 512 channels. FSX and SDR-14 receivers use the number of channels you entered here. When using RTL Bridge or other receiver connected via the same TCP connection, the number of channels is determined by the data source configuration and is applied automatically. The number of channels is then over-ridden by the channel number provided by the SDR interface.

### Number of Displayed Spectra:

Each spectra occupies a single vertical row of pixels. You may display from 600 to 1200 at one time.

### Number of Spectra to Average:

The number of spectra to average together when displaying a live averaged view. To display the *Averaged View* you select the **Avg** checkbox.

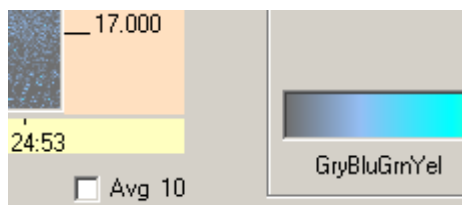
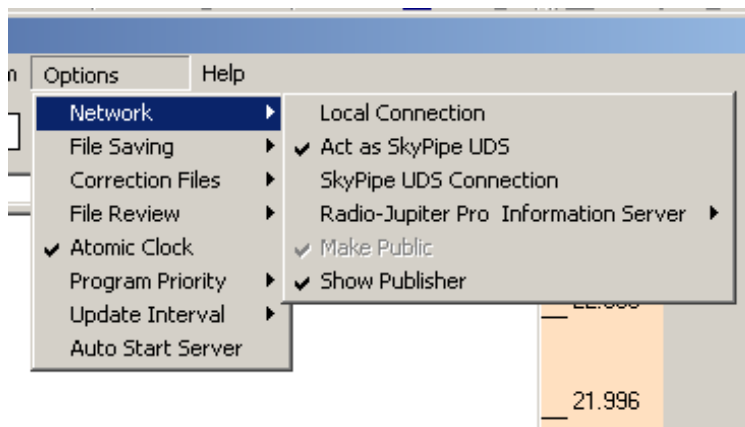

*Illustration 20: Checking the "Avg" box forces the averaged view of spectra. The number of spectra averaged is set under the Spectrogram menu.*

If you are displaying a single receiver spectrograph, then by default the lower chart will display the live Averaged View in which each displayed spectrum will be an average of **Number of Spectra to Average** size. When displaying a live chart from a dual receiver spectrograph, both the displays will show the Averaged View when this checkbox is selected.

## Options Menu

### Network Sub-menus



*Illustration 21: Many configuration options are hosted under the Options Menu.*

### Local Connection

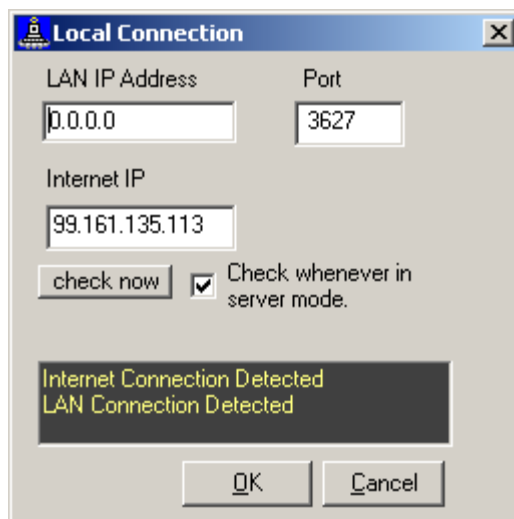

The Local Connection Window provides Internet Protocol connection information for RSS. The default **Port** number is 3627. It may be changed if you have multiple computers running RSS on your LAN or if there is a port conflict with another program using this port.. The **LAN IP Address** can remain at 0.0.0.0 unless you intend to operate in **Server Mode**. In that case you should assign a permanent LAN IP to the PC to facilitate Port Forwarding in your router. You do not have to configure the Internet IP unless it is a permanent IP address. RSS checks the Internet IP by sending a query to the Radio-Sky website so whenever in server mode, check this box checked you have a permanent IP address.

### Act as SkyPipe UDS

A User Data Source or UDS is a program that provides a path for charting data in Radio-SkyPipe. To act as a UDS is simply to send strip chart data over a TCP connection to the Radio-SkyPipe strip chart program. This options turns on/off this connection.

### SkyPipe UDS Connection

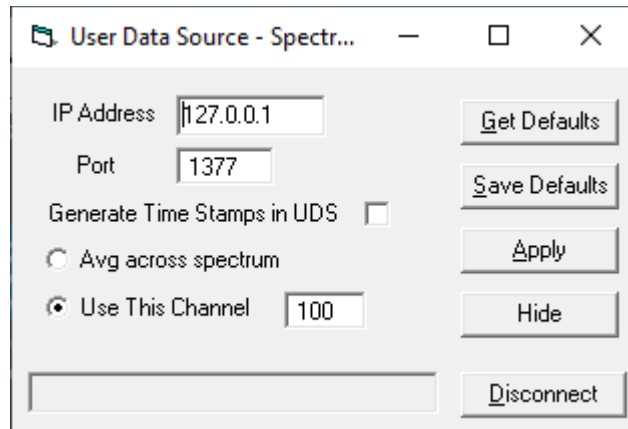

Beginning with RSS version 2.9.63 the UDS connection to Radio-SkyPipe can send either the average across the entire spectrum *or send the value from a selected channel*. Use the radio buttons to select which option you want. If using the single channel option you will want to designate which channel to sample from. Sample numbers will run from one to the number of channels in your spectrogram with the highest frequency channel as channel number one. You may select a channel number graphically by loading a SPS file, right clicking on the channel you want, and selecting **Set SkyPipe UDS Channel**

If Radio-SkyPipe is run on the same PC as RSS, then we use the loopback **IP address** (127.0.0.1) for the UDS connection, otherwise you must use the LAN IP address. Make sure the **Port** matches the port selected in the UDS configuration in Radio-SkyPipe. Check **Generate Time Stamps in UDS** if you want RSS to manage the time stamps. Make sure to use the **Save Defaults** and **Apply** buttons to make your selections permanent.

## **Radio-Jupiter Pro Information Server**

### **RJP JIS Options**

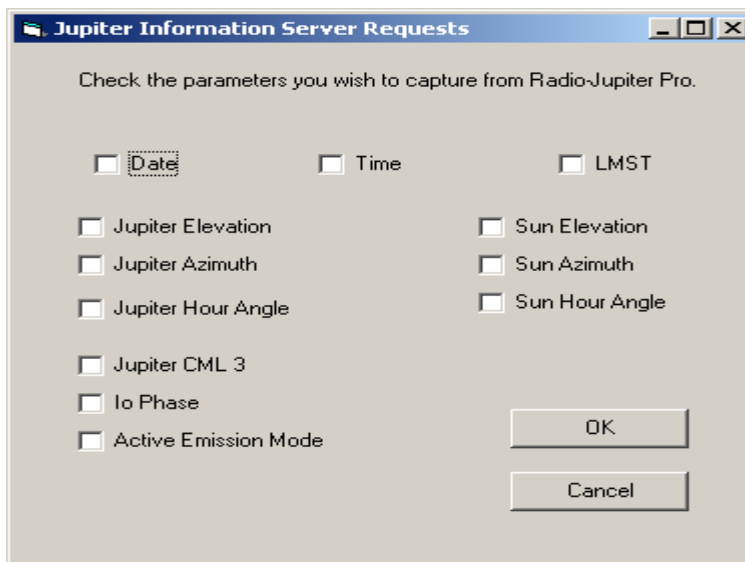

Select which data you want to receive from the Jupiter Information Server in Radio-Jupiter Pro. Select those items that you wish to use in Banners using the <JIS> tag. This tag will be replaced with an information string using the items you have selected

### **Connect to RJP**

Automatically connect to Radio Jupiter Pro's Jupiter Information Server.

### **Make Public**

When in Server Mode make your observatory visible in the Available Servers List so others can connect to you.

### **Show Publisher**

Shows the RS Publisher window for monitoring server connections and publishing of the server information.

## File Saving Sub-menus

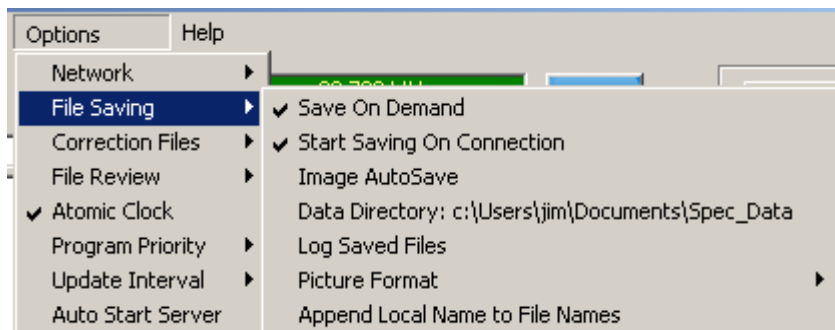

### Save on Demand

Allows manual data file saves whenever the chart is running using the **Start / Stop Saving** button.

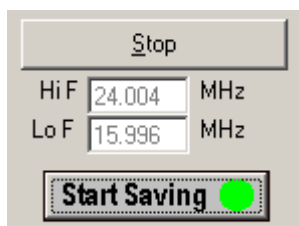

Files are saved as individual SPS files using this method.

### Start Saving on Connection

When starting a chart in any mode begin automatically saving immediately.

### Image AutoSave

Use this feature to automatically save images of observation spectra. This is especially useful for use on PCs that also host a web server. Using [Abyss Web Server from Aprelium](#), we have used this method at the Lanihuli radio observatory to allow access to spectrograms via a browser.



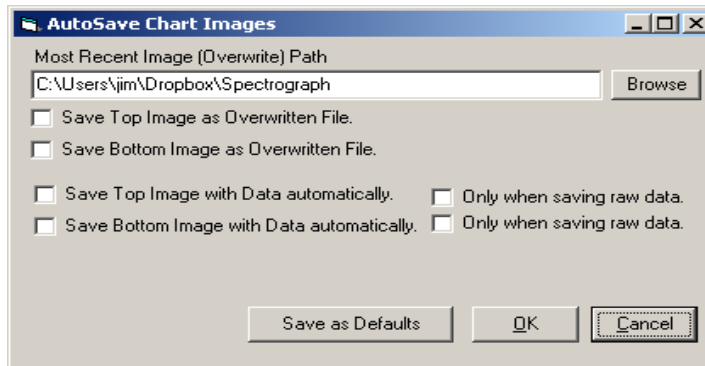

*Illustration 22: The AutoSave Chart Images window controls where and how spectrogram image files are automatically saved.*

### Data Directory

This is the default bottom level directory where you will keep all data files. It is important that the Data Directory be placed in a directory with a liberal permissions policy so that the data can be easily accessed. By default, the Data Directory is created as a sub-directory of *My Documents*. Data files are saved under a sub-directory of the Data Directory named to match the Observatory name. Data from local and client usage is handled the same way.

Beneath the Observatory directory the data files are sorted into Year, Year-Month, and Year-Month-Day sub-directories. For example, *C:\Users\jim\Documents\Spec\_Data\KYRO\_TEST\1906\190614\190614203030.sps* fully describes the location of a data file starting at 20:30:30 UT (hours/minutes/seconds) on June 14, 2019.

### Log Saved Files

Keeps a record of all saved files in a text file in the data directory. SavedFiles.txt

### Picture Format

Select between JPG, and PNG formats for saved images. See [Saving Images](#).

### Append Local Name to File Names

This option will include the Observatory name as part of the file name.

### Correction Files

Correction files were developed to flatten the response of a typical antenna array and receiver combination. *You are not required to use correction files.* When data is collected, the correction file is used to amplify or attenuate the *appearance* of the signals in each channel. Developing a correction file begins with creating a **seed** file, which is in turn made by collecting and averaging quiet sky data. You can **Save Correction Seed File from Live Data**, or **Save Correction File From Loaded File View**. Using the former method requires selecting a duration for **Correction Test Duration**. A CSV (comma separated values) format is used for the correction seed file. It can be manipulated mathematically to fine tune its characteristics. This is beyond the scope of this help file.

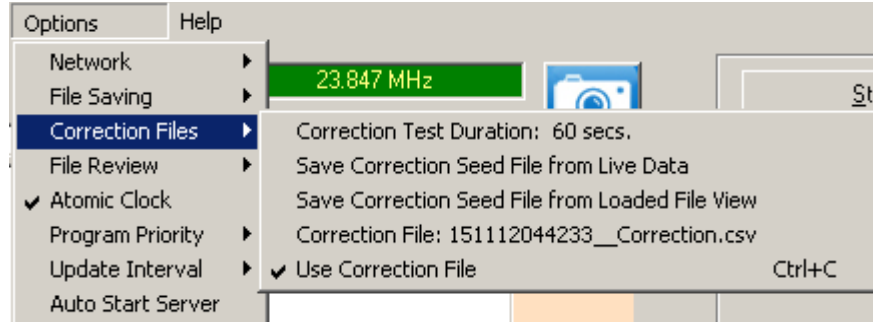

Whether or not the Correction File is applied is controlled by **Use Correction File**.

### Atomic Clock

Selection of this option triggers use of the Radio-Sky SNTP Clock Client, a system clock correction tool.

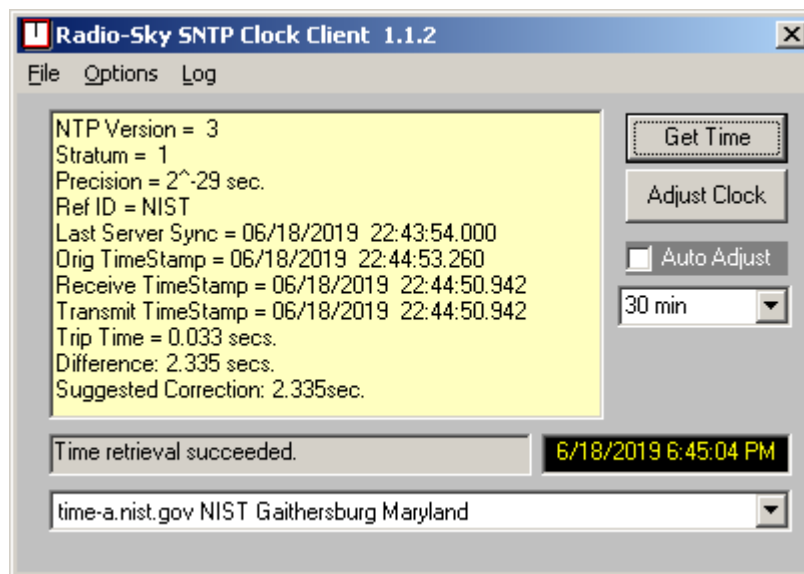

The only parameter that may need to be adjusted on the SNTP Client is the time server it will use to retrieve the time. Using the NTP Pool option selects a server automatically, however, it is preferable to select a NIST designated server from the list for best performance and security. If you have a in-observatory time server, you will want to use that server instead. To add a dedicated time server to the list you must add it to the SNTPtimeservers.txt file in the RSS program directory.

In the partial listing of the SNTPtimeservers.txt file below I have added two lines for the GPS based time server from [Reeve Engineers](#) using a permanent IP address on my local LAN. The two added lines, shown in blue, give name displayed, followed by the IP address of the server. The [Reeve Engineers GPSNTP-Pi time server](#) is based upon a Raspberry Pi and may be configured via the Ethernet connection using telnet. Follow Reeve's instruction for configuring the server to use a fixed IP address and put that address in the list as shown below (Text 1).

```

NTP Pool
pool.ntp.org
GpsNtp-Pi
192.168.1.115
time-a.nist.gov NIST Gaithersburg Maryland
129.6.15.28
time-b.nist.gov NIST Gaithersburg Maryland
129.6.15.29
time-a.timefreq.bldrdoc.gov NIST Boulder Colorado
32.163.4.101
time-b.timefreq.bldrdoc.gov NIST Boulder Colorado
132.163.4.102
...

```

*Text 1: Partial listing of the SNTPTimeservers.txt file showing addition of a GPSNtp-Pi server on the local area network.*

## Program Priority Sub-menus

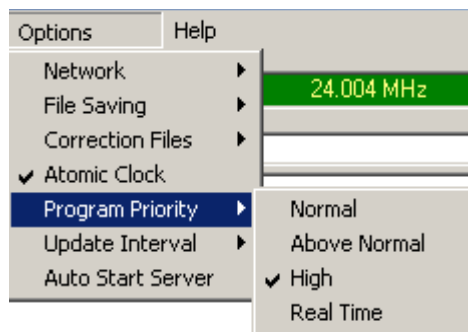

On some computers it may be helpful to increase the Windows program priority of RSS. This means that Windows will “pay more attention” to RSS than other programs using **Normal Priority**. Avoid using the **Real Time** option unless absolutely necessary as it may cause the computer to freeze.

## Update Interval

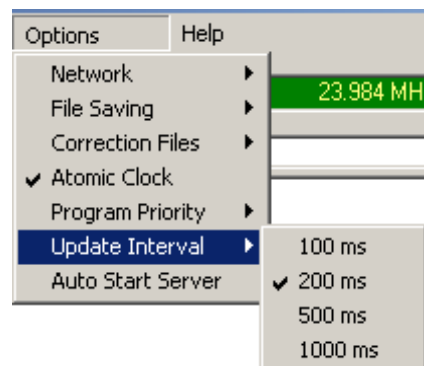

This option sets how often the chart display updates when collecting data. Use the update period that gives you the the best performance. This does not control the actual sample rate, only the rate at which

spectra are displayed. The numbers are in milliseconds (ms). 1000 ms = 1 second.

**Autostart Server** – When selected the program will automatically enter server mode and begin data collection on program startup. This is especially useful for unattended server operation. If you have **Make Public** selected in your [Network Settings](#) then the server will be published in the Available Servers list for public connections.

## Calibrator Control Panel

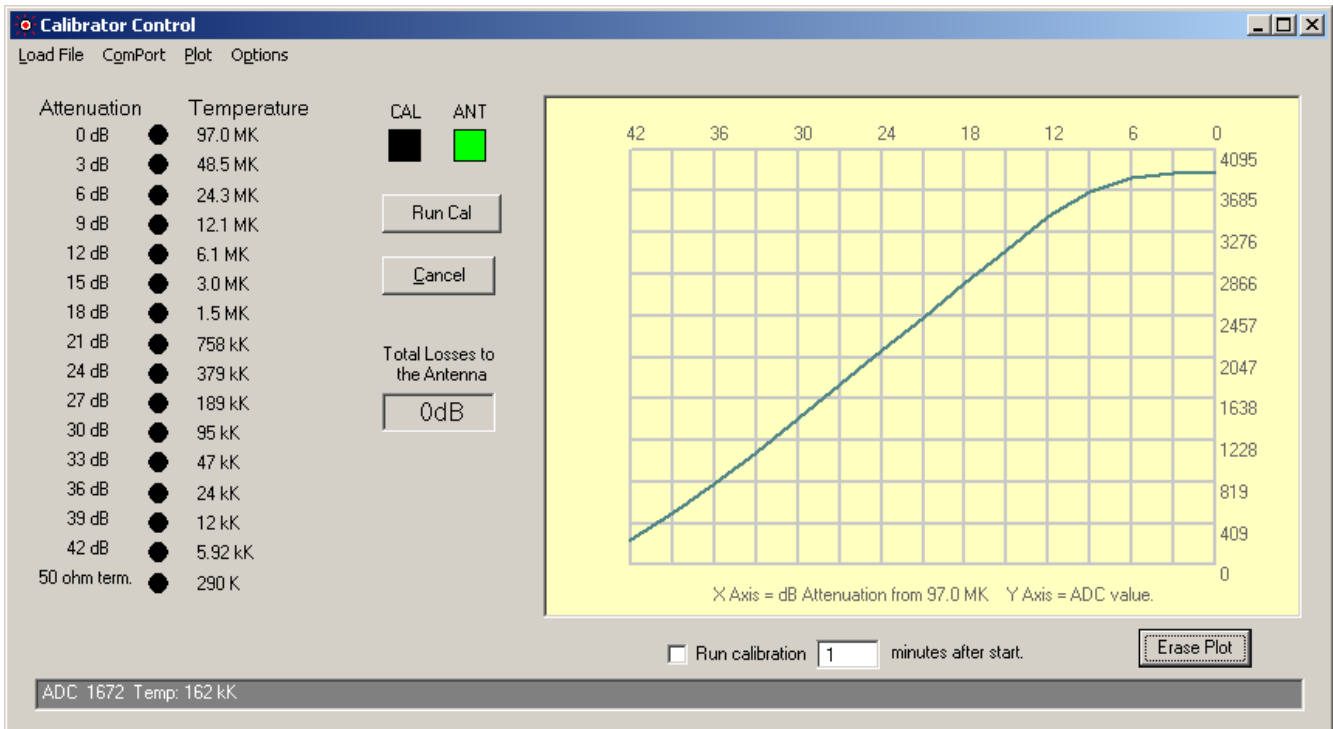

*Illustration 23: The Calibrator Control panel allows automatic calibration of Radio-Sky Spectrograph when connected to the MK2 calibrator.*

This window can be called from **View / Calibrator Panel** in RSS or pressing **CTRL+B** from the main RSS window. This calibrator control is specific to the MK2 calibrator<sup>2</sup> and uses a serial com port to communicate with RSS. The calibration sequence is as follows:

- A start calibration command is issued either by pushing the **Run Cal** button or automatically using the **Run calibration X minutes after start** option.
- A “S” command is sent to the MK2 Arduino board.
- The antenna relay in the MK2 switches the receiver from the antenna to a 50 ohm termination.
- The calibrator then attaches the receiver to the MK2's noise source through a decreasing series of attenuations from 42 dB to 0 dB. Each step increases the noise temperature seen by the receiver by 3 dB. A green “LED” indicates the current step on the cal control panel.
- At each step, after a one second delay, the current step value and noise temperature is sent to RSS. For the next 4 or 5 seconds, RSS will monitor and save the values seen in each channel.
- The last step has the calibrator returning to the terminated input.
- The antenna is reconnected.
- RSS is told by the calibrator control panel that the calibration has ended. RSS then computes the average ADC value seen at each calibrator step and saves it along with the corresponding noise temperature (adjusted for feedline loss).
- The results of the calibration are saved in a CSV (comma separated values) file with the same

<sup>2</sup> A compatible open source step calibrator design made with off-the-shelf modules will soon be released. Spring 2022

- name as the current data file modified with *-Cal.sps* as its ending.
- Finally, a plot is drawn of the results of the calibration.

Cal file name is a modification of the data file name with -Cal added

Channel number, with zero corresponding to the highest frequency.

Number of noise spectra averaged to derive the Raw Value

	A	B	C	D	E
1	Channel	Frequency	Noise Temperature	Raw Value	Num Samples
3694	404	16113072	757812	2035.3	23
3695	405	16093540	757812	2014.6	23
3696	406	16074008	757812	1990.1	23
3697	407	16054476	757812	1970.1	23
3698	408	16034944	757812	1944.4	23
3699	409	16015412	757812	1942.3	23
3700	410	15995880	757812	2252.4	23
3701	0	24004000	1515625	2180.1	22
3702	1	23984468	1515625	2208	22
3703	2	23964936	1515625	2232	22
3704	3	23945404	1515625	2255.9	22

Frequency in Hz of this channel.

Noise Temperature in this step in degrees Kelvin.

Magnitude of the averaged noise samples. (0 - 4095)

*Illustration 24: RSS calibration file viewed in OpenOffice Calc.*

You can import the calibration CSV file into Excel or [Open Office Calc](#). More importantly, when you load an observation, RSS will look for and load the calibration file if it exists in the same directory as the sps data file. When you load a sps file into RSS that has an accompanying calibration file, you will find that moving the mouse over a segment of a loaded spectrogram provides a corresponding temperature in the status bar at the top of the program.

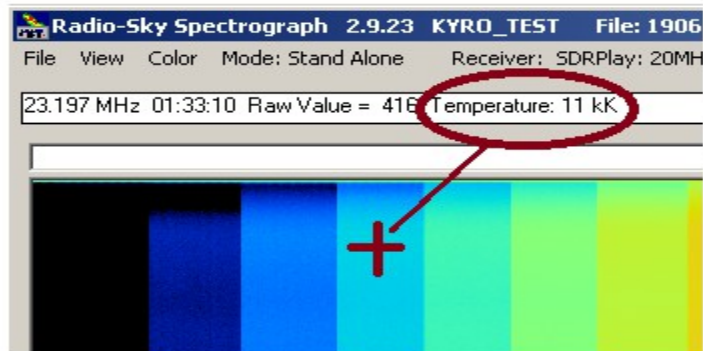

*Illustration 25: Antenna Temperature in kilo-Kelvins. Includes line losses.*

## Calibrator Control Panel Menus and Buttons

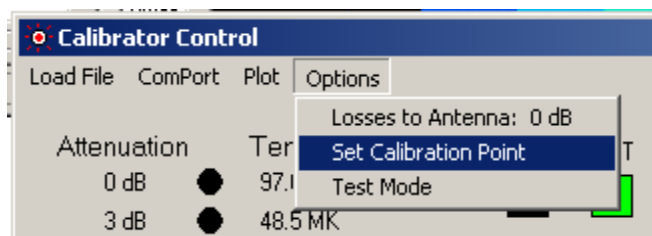

*Illustration 26: Options for the Calibrator Control panel.*

### Load File

Allows you to load a calibration CSV file. The file must have the same number of channels and frequency range as the loaded sps data file for it to be used. If you know that the calibration applies to the data file you can save a new calibration file with a new name which associates the calibration values with the loaded data file. The original calibration file is not modified. The next time you load the same observation, it will be calibrated.

### ComPort

Enter the com port to which the MK2 calibrator is connected. The com port should appear in your Device Manager as *Arduino Uno* or something similar.

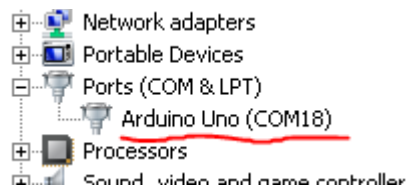

*Illustration 27: The Windows Device Manager can tell you which com port your MK2 is using.*

## Plot

Draws a plot of the currently loaded calibration file. (Illustration 26) The plot generated is a useful tool for adjusting your system for best compromise between sensitivity and dynamic range. If you are only looking for weak signals you might optimize for that by minimizing front end attenuation and increasing gain with the knowledge that your receiver might saturate well before the peak of solar burst. This clever plot, imagined by R. Flagg, shows you the minimum and maximum signal levels that you can detect. It shows you where non-linearities occur in your system such as, but not limited to, at what level gain compression begins.

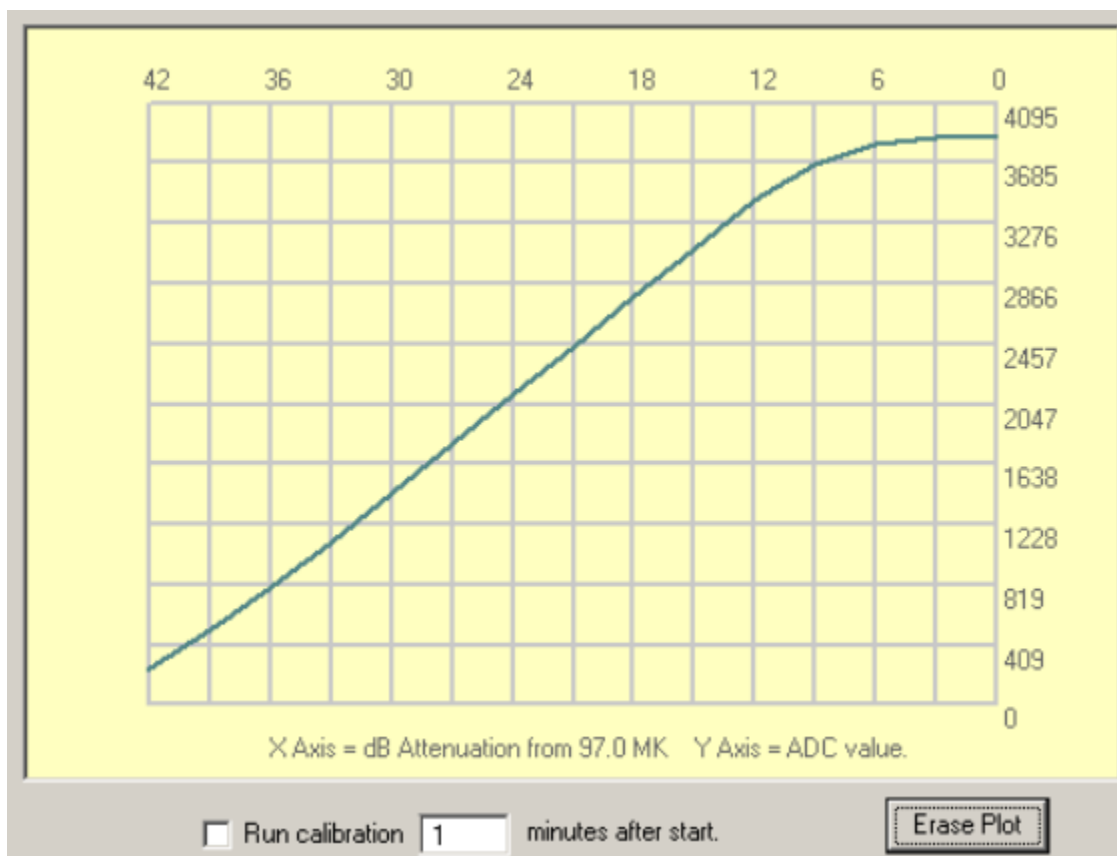

*Illustration 28: Plot window from the Calibrator Control panel. In this plot we can see that gain compression is occurring at the higher noise levels.*

The Y axis is the range of values that the 12 bit data format supports. These values are referred to as



“ADC” values in the caption, but could be mapped to any 12 bit receiver input. The X axis is the amount of attenuation being applied to noise source signal for the given calibration step.

The plot is not automatically erased when you run another calibration. The new plot is laid on top of the grid while the older plots sink below it. New plots appear in random shades of green, helping to distinguish between overlapping plots. When you want a fresh plot screen, click the **Erase Plot** button at the lower right of the window.

To see the corresponding noise temperature of a point on the plot can be seen in the status bar when moving your mouse over the image.

## Options/

### Losses to Antenna

In the typical system the calibrator will sit indoors next to the computer and receiver. The antenna can be connected by coax cable many meters away. This means that any signal arriving at the receiver will have been attenuated by the losses that occur in the coax and connectors leading to the antenna. If you had 3 dB of loss in the path, then whatever signal seen at the receiver was twice as strong as measured at the antenna. Thus to record the actual antenna temperature we need to multiply the received signal by 2. ( 3 dB loss = power ratio of 2:1). The calibrator sits next to the receiver and thus sees no losses that are not also seen by the antenna. You must specify the losses to the antenna in decibels in order to have your files properly calibrated. *If you make system changes that affect these losses, you must update this parameter.*

### Set Calibration Point

Your calibrator's maximum temperature goes here. A MK2 calibrator will have this value measured when it is built and you will be provided with this parameter.

### Test Mode

A mode for testing the calibrator at minimum attenuation (= maximum noise power). When activated, the antenna relay is switched to the noise source and the attenuators set to 0 dB of attenuation. Press the **Cancel** button to end.

### Cancel Button

The cancel button may be pressed at any time while a calibration is running. When the button is pushed a “C” message is sent to the MK2. The calibrator will not cancel until it ends the current step. The Cancel button may also be used to cancel the countdown to an automatic calibration.

### Run calibration X minutes after start

This option will trigger the automatic display of the Calibrator Control panel and perform a calibration

when you start a new Stand Alone or Server Mode observation. In practice, you should make the pause at least 2 minutes before starting the calibration. This gives plenty of time for the various software components to start up and communicate with each other.

### **Known Issue with Starting the MK2 Calibration**

There is an issue with the Microsoft com port interface where it *sometimes* will ignore the first request open. This problem also sometimes occurs when starting FS spectrographs. The good news is that once the com port has been opened the issue doesn't usually happen again until there is a restart of the program. All that usually needs to be done is to click a second time on the Cal button. So take note of this issue and monitor until the first automatic calibration begins. If you see that nothing is happening 10 seconds after the calibration starts (no temperature LEDs turn green), click the Cal button manually. Alternatively, you can just do a manual calibration whenever you restart the RSS executable so you don't have to wait around for the automatic one. The same fix follows, if the manual calibration does not start (light up the LEDs), then click it one more time. Unless, the program (not just the data collection) is actually closed in Windows, the problem should not happen again on consecutive days of observing.

You might ask, "Why doesn't the program just automatically try to start the cal a second time when it fails to connect?" It does. It just doesn't seem to work, and the button push is necessary. It is a mystery.

## Spectrogram Review Menu

After loading a file for review, you may *right-click* on the spectrogram to obtain the following functional menu (Illustration 27):



*Illustration 29: Right-click menu for examining spectrograms.*

## Annotate

Annotations are text labels that you can apply to any data point in the spectrogram. These notations are saved in comma separated values (CSV) file with the same base file name as the SPS data file bit with the new ending “-Annotations.csv”. For example, a data file named 190606143000.sps would have an annotation file named “190606143000-Annotations.csv” placed in the same directory. When you load the data file into RSS, the program will look for the corresponding annotations file and load it if present.

To add an annotation to a file right-click on the spectrogram at the data point that you wish the annotation to correspond to. Select “Annotate” from the drop-down menu. You will then see a list of options similar to the one below.

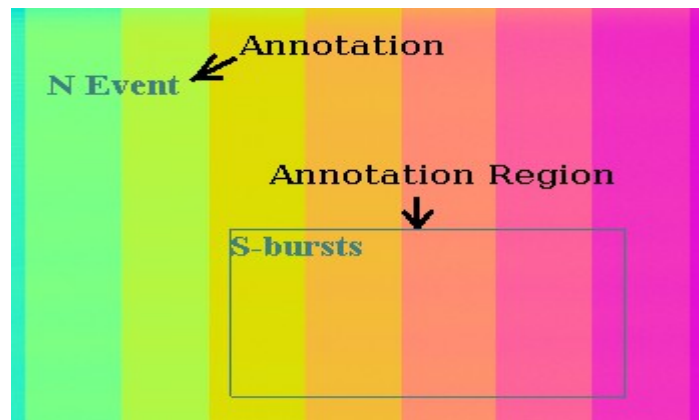

*Illustration 30: The customizable Annotate pop-up menu is accessed by right clicking on a loaded spectrogram and selecting Annotate or Annotate Region.*

The top portion of the list is a predefined list of notations that is kept in the RSS directory with the file name “Annotations.txt”. You may edit this list with notepad to add or remove these entries. This list should be limited to notations that you commonly use. The “CUSTOM” option allows you to type in a one time use notation of your choosing. That entry will not be added to the permanent list unless you do so manually. “CANCEL”, simply cancels this annotation.

## Annotate Region

This is similar to an ordinary annotation but pertains not to a single point on the spectrogram, but rather to a range of frequencies and times. You must draw a rectangular region with the mouse onto the spectrogram after selecting or entering the new annotation.



*Illustration 31: Annotations are text fields tied to specific points in a spectrogram. An Annotation Region includes a box defining the boundaries if the area of interest.*

## Find Slope Between Points

Some radio signals change frequency over time and the rate of change displayed can be useful in deducing the nature of the source of the signal. This software tool allows you to calculate the rate of change in kilohertz per second by drawing a line between two points on the display.



display (1). This is used in dual receiver spectrograms. Single receiver spectrograms will always appear in chart 0.

If you are running [Radio-Jupiter Pro](#) while adding annotations, and you have turned on the [Jupiter Information Server](#), then you may automatically record the CMLIII (Jupiter's central meridian longitude in System III) as well as the Io orbital phase. These two parameters are important in many studies of Jupiter's radio emissions.

Your editing options are limited to adding new annotations and using the **Delete** button to delete the selected annotation. You cannot modify an annotation once it has been added. You must delete and replace it.

Clicking the **Save** button will save the current annotation list with a file name relating it to the loaded data file. *This will overwrite any annotation file with the same name.*

Use the **Hide between entries** checkbox to keep this window out of the way when entering multiple annotations.

When you click the **Close** button you will be given the option to save these annotations if you have added or deleted annotations.

**Go to Selected Annotation** is a powerful button that allows you to quickly navigate to a given annotation in the spectrogram. This could be very useful to researchers.

## Combining SPS Files

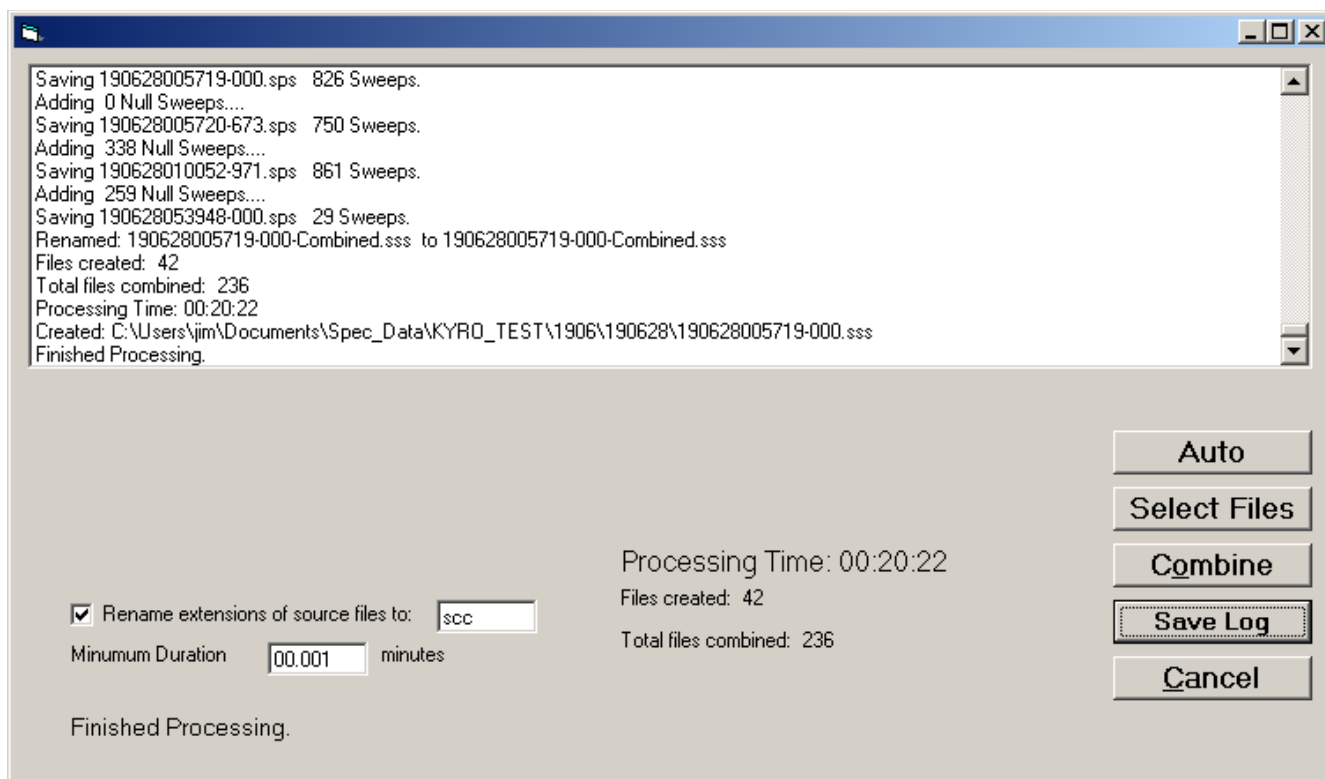

*Illustration 34: Combining SPS files requires use of this special tool under File / Combine Data Files.*

*Warning: It is strongly suggested that you back up your data before following these procedures.*

You may want to combine sequential data files for reasons of archive simplicity where files created on a single day are combined for display and searching of metadata. Manually combining these files is unpractical. To combine SPS data files use the utility shown above accessed via the *File / Combine Data Files* menu item. This utility allows manual selection of the files to be combined using the **Select Files** button, or recursively combining all same-day files in a directory using the **Auto** button.

When two files are combined, they must include sequential data. They may overlap but the earlier beginning file will be the data provider to the combined file for the overlapped period. If there is a gap between the ending of the first file and the start of the second file, that gap will be filled with blank spectra (all zeros). This is inefficient in terms of file size, but maintains compatibility with past display methods.

## Renaming Files

Before selecting and combining files you must decide what you want to do about the resulting file name conflict. The naming convention for SPS data files is YYMMDDhhmmss.sps with the date represented corresponding to the beginning time of the observation. The newly created combined file needs to have that same beginning string of digits. If you choose not to rename the original files, then

the name of the new file will be modified with `-Combined.sps` as its new ending for example: `190701001200-Combined.sps`. Uncheck the **Rename extensions of source files to:** checkbox.

The other option is to rename the original sps files with a new extension. In the example above the new extension is “`scc`”. Now the newly created combined file will have the expected file name format of `YYMMDDhhmmss.sps` and the original files can be readily identified and deleted if desired. Check the **Rename extensions of source files to:** checkbox to use this option and specify the file extension you want to use.

**Minimum Duration** \_\_\_ **minutes** sets the smallest acceptable file size that will be included in the combined file. This prevents you from needlessly processing short snippets of data that accumulate when test equipment or adjusting settings.

## Auto button

Using this button gets you prompted to select a directory.

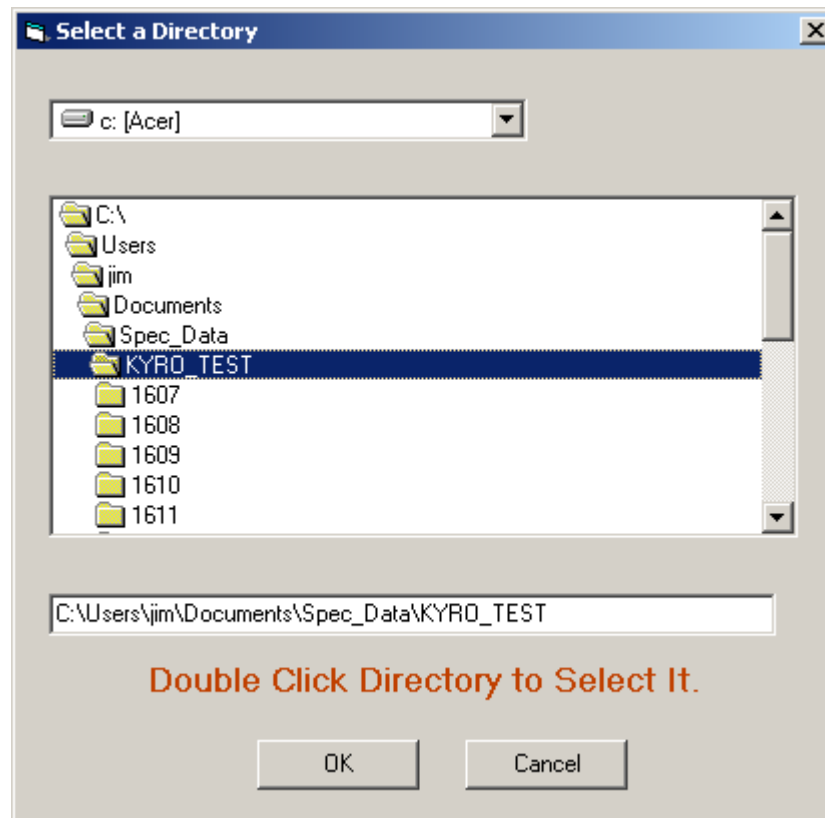

In the example above I have selected the observatory level directory `KYRO_TEST`. Double click the directory you want and make sure it shows up in the window below the directory tree. Then click OK. The combining utility will begin searching through the sub-directories of your chosen top directory. SPS files occurring within the same sub-directory will be analyzed for combining.



Files are checked for minimum length then correspondence in location, equipment used, number of channels, and frequency range. All must agree in order for the files to be combined.

## Select Files button

The Select Files button allows you to manually gather the list of files to be combined. You may use the CTRL or Shift keys to select multiple SPS files from the Select Files dialog box. As you select files, they will appear in the action list that dominates the file-combine utility screen. When you have selected all of your files, press the **Combine button**.

It may take a while to process a large number of big files. You are alerted to the activity in the action list. A log is produced of the actions taken and is loaded into notepad.

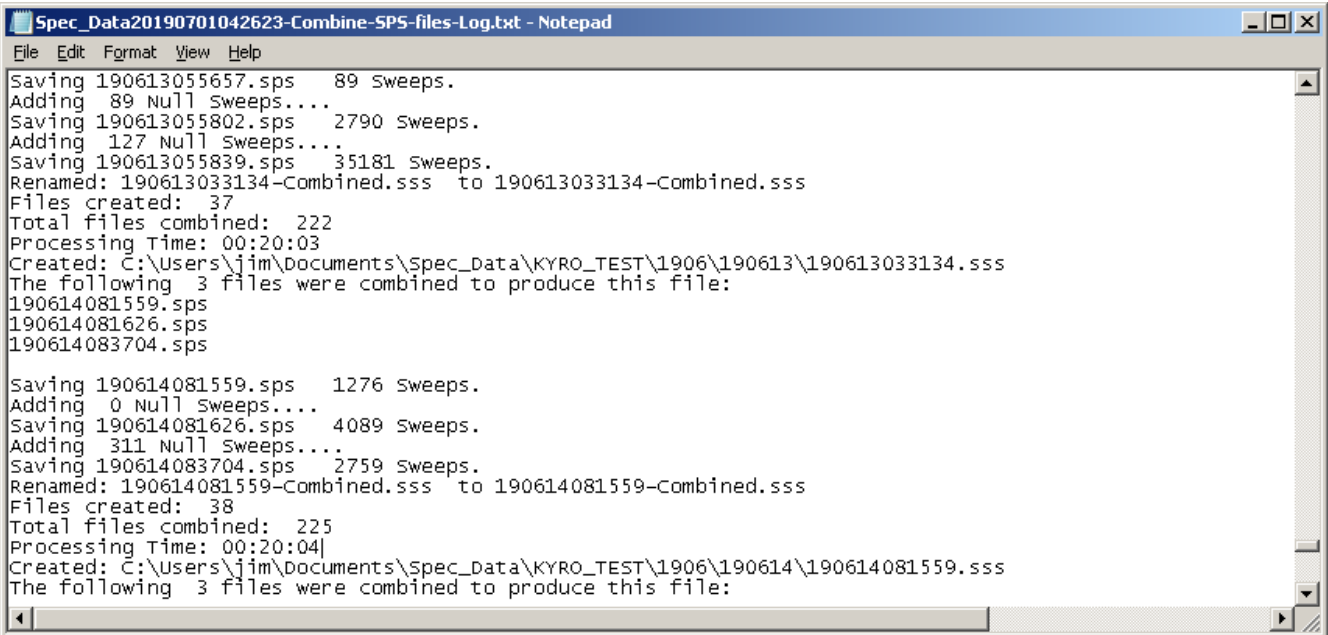
A screenshot of a Notepad window titled "Spec\_Data20190701042623-Combine-SPS-files-Log.txt - Notepad". The window contains a text log of file combination actions. The log is divided into two main sections. The first section details the combination of files 190613055657.sps (89 Sweeps) and 190613055802.sps (2790 Sweeps) into 190613033134-Combined.sss, with a total of 222 files combined and a processing time of 00:20:03. The second section details the combination of files 190614081559.sps (1276 Sweeps), 190614081626.sps (4089 Sweeps), and 190614083704.sps (2759 Sweeps) into 190614081559-Combined.sss, with a total of 225 files combined and a processing time of 00:20:04. The log also lists the files that were combined to produce each of these files.

```
Spec_Data20190701042623-Combine-SPS-files-Log.txt - Notepad
File Edit Format View Help
Saving 190613055657.sps 89 Sweeps.
Adding 89 Null Sweeps....
Saving 190613055802.sps 2790 Sweeps.
Adding 127 Null Sweeps....
Saving 190613055839.sps 35181 Sweeps.
Renamed: 190613033134-Combined.sss to 190613033134-Combined.sss
Files created: 37
Total files combined: 222
Processing Time: 00:20:03
Created: C:\Users\jim\Documents\Spec_Data\KYRO_TEST\1906\190613\190613033134.sss
The following 3 files were combined to produce this file:
190614081559.sps
190614081626.sps
190614083704.sps

Saving 190614081559.sps 1276 Sweeps.
Adding 0 Null Sweeps....
Saving 190614081626.sps 4089 Sweeps.
Adding 311 Null Sweeps....
Saving 190614083704.sps 2759 Sweeps.
Renamed: 190614081559-Combined.sss to 190614081559-Combined.sss
Files created: 38
Total files combined: 225
Processing Time: 00:20:04
Created: C:\Users\jim\Documents\Spec_Data\KYRO_TEST\1906\190614\190614081559.sss
The following 3 files were combined to produce this file:
```

*Illustration 35: A text log of the actions taken when files are combined is displayed in Notepad.*

## RTL Bridge Help

RTL Bridge is a VB6 application that accepts I-Q data from an RTL dongle via the Osmocom rtl\_tcp application. RTL Bridge then supplies reduced data to the Radio-Sky Spectrograph program and/or the Radio-SkyPipe strip chart program. This is an experimental program from my perspective. It can crash! I expect many bugs. Also, it is not a spectral display program even though it does have a crude spectral display. RTL Bridge is intended as a utility to accomplish the specific goal of providing an interface from two of my earlier programs to an RTL dongle.

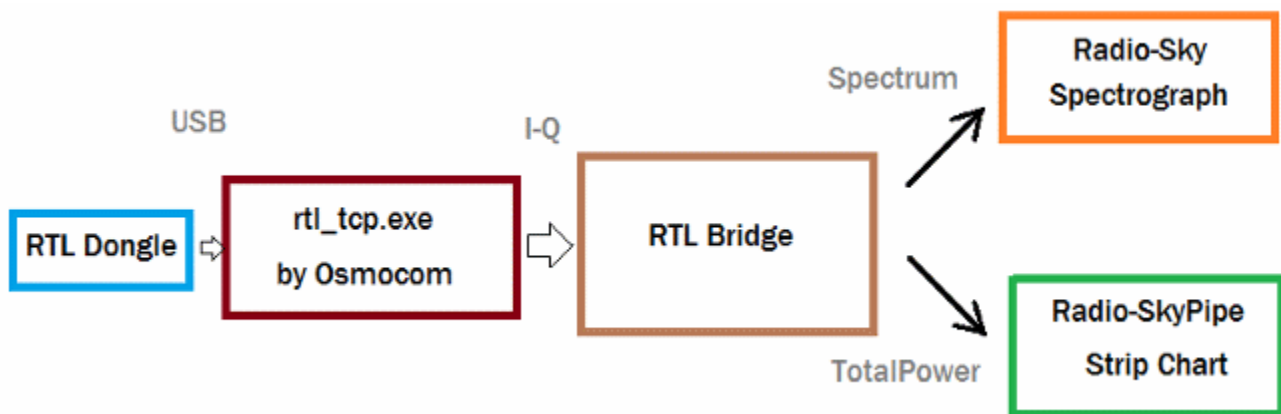

*Illustration 36: Diagram of data flow when using RTL Bridge.*

Radio-Sky Spectrograph displays a waterfall spectrum. It is not so different from other programs that produce these displays except that it saves the spectra at a manageable data rate and provides channel widths that are consistent with many natural radio signal bandwidths. For terrestrial, solar flare, Jupiter decametric, or emission/absorption observations you might want to use RSS.

Radio-SkyPipe is a souped-up strip chart program which plots signal strength over time. When getting its data from RTL Bridge, RSP is plotting the total power in the spectrum covered by the RTL receiver centered around its set frequency. The raw values are proportional to power, but you will have to apply a function via the RSP Equations feature to apply a calibration if you want absolute values. For signals that do not have significant spectral structure of interest, this would be the preferred way to plot the data.

### Running RTL Bridge

First make sure your dongle is working with your Windows computer. I suggest installing SDR# using the instructions at: <http://rtlsdr.org/softwarewindows>. SDR# will be useful for listening to signals, a feature not available at this time with RTL Bridge. You do not need to have SDR# installed for RTL

Bridge to work, however, you must at a minimum install the USB drivers for the dongle radios installed via the Zadig application referenced on the web page.

Next install or update your copy of Radio-Sky Spectrograph to version 2.9.25 or higher. This installation will include RTL\_Bridge.exe and all of the files you need to support it including the rtl\_tcp application and its supporting libraries.

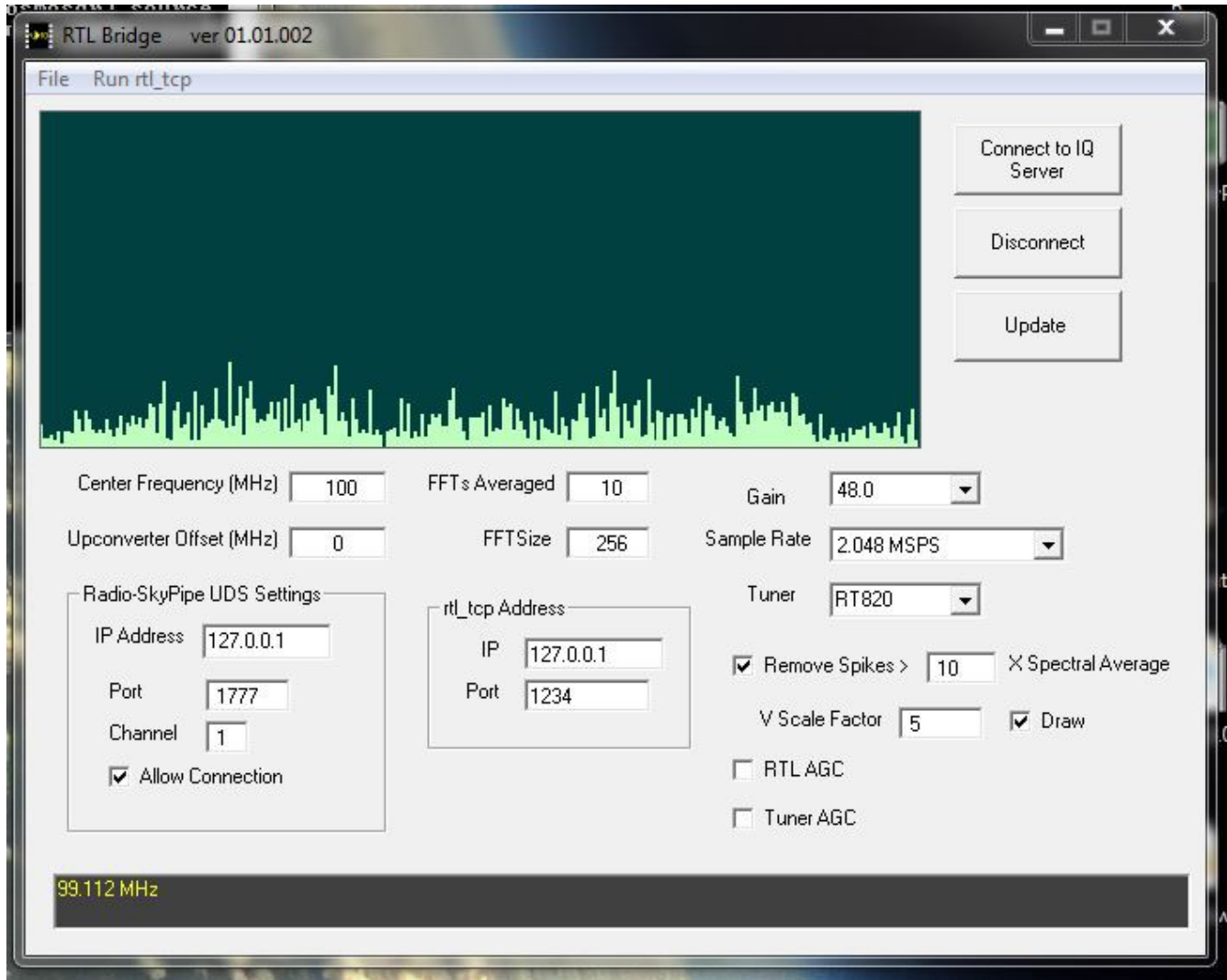

*Illustration 37: RTL Bridge window.*

When you start RTL Bridge [ *Start / Radio-Sky Spectrograph / RTL Bridge* ] for the first time you will see the above window which reflects the default settings.

## Settable Parameters

**Tuner** – Set this first. Currently it only allows selection of the E4000 or RTL820 tuners. If your dongle receiver has a different tuner, the program will still work but may not set the gain value for the tuner.

**Center Frequency (MHz)** – Set to the frequency in MHz at the center of the passband you wish to observe.

**Up-converter Offset (MHz)** – If you are using an up-converter ( such as Ham-It-Up ) so that you can observe at frequencies below the reception range of the RTL dongle set this parameter. If your up-converter has a 100 MHz crystal it will make a signal appearing at 10 MHz at its input shift to 110 MHz for detection by the dongle. In this example 10 MHz would be used as the Center Frequency and 100 MHz as the Up-converter Offset.

**FFTs Averaged** – RTL Bridge processes incoming I-Q data as quickly as it can. This parameter lets you decide how many spectrum calculations to average before outputting to Radio-SkyPipe or Radio-Sky Spectrograph. You can slow down the number of spectra recorded per second by adjusting this number. Experiment.

**FFT Size** – Allowable sizes are 128, 256 bins. This will equate to the number of channels recorded in RSS.

**Gain** – This is the gain setting for the dongle. I believe setting to zero or -1 will activate AGC, probably not what you want to do!

**Sample Rate** – Drop down box allows you to choose the sample rate for the dongle receiver. The sample rate in an I-Q receiver is equal to the maximum bandwidth of the radio. In other words, if you select a sample rate of 2.4 MHz, the output spectrum will cover 2.4 MHz centered on your selected center frequency. **Warning – many of the lower sample rates seem to make the performance very poor.** I don't know why.

**Remove Spikes > A x Spectral Average**– provides a crude way to eliminate some spikes and the center frequency artifact spike.

**V Scale Factor** – provides a simple way to scale the display.

**Radio-SkyPipe UDS Settings** – parameters define the IP address and port that RTL Bridge will use to listen for a Radio-SkyPipe UDS connection. The channel in RSP that will receive the data is also defined (1-8). Finally, there is an Allow check box that must be checked before a UDS connection will

be accepted. These parameters must match the corresponding fields in the UDS setup screen in RSP. See: *Using Radio-SkyPipe with RTL Bridge* below.

**rtl\_tcp Address** – The default 127.0.0.1 and Port 1234 should be used unless the dongle is located on another PC.

**Draw** – Un-check to remove the annoying spectral display and maybe speed it up just a bit on a marginal PC.

**RTL AGC** - Toggles AGC in the RTL chip. Not sure how this really works.

**Tuner AGC** - Toggles AGC in the tuner chip. Again, I don't know the details. Experiment and tell me what you find.

*When you have made changes to any of these parameters click the **Update** button to make the changes effective.*

Changes to parameters most RTL parameters do not require stopping and running rtl\_tcp again, however some changes such as FFT Size will require Disconnect , Update, and pressing Connect to IQ Server again.

RTL Bridge uses the default address and port of the rtl\_tcp application 127.0.0.1:1234. I intend to make this configurable to accommodate more than one dongle in the future if possible.

## **Buttons (and a menu item ) You can Click**

Click **Run rtl\_tcp** to run start\_rtl\_tcp.bat which in turn runs the rtl\_tcp program with start up parameters that reflect your choice of center frequency, gain, and sample rate.

Press **Connect to IQ Server** to connect to a running instance of rtl\_tcp.exe

Press **Disconnect** to stop receiving I-Q samples from rtl\_tcp. Any connection to RSS or RSP will also be broken.

When you press **Update**, a new start\_rtl\_tcp.bat file is written with center frequency, gain, and sample rate parameters that you have selected. Other parameters are also updated in memory and await a new press of the Connect to IQ Server to be activated.

## **Using RTL Bridge with Radio-Sky Spectrograph**

Radio-Sky Spectrograph (RSS) must reside on the same PC with the RTL Bridge program. Communication between RTL Bridge and RSS occurs over port 8888 of the loop-back address of 127.0.0.1. This is hidden from the user but may be of interest if you have a port conflict.

Run RTL Bridge as described above.

In RSS go to **Options / Radio** and select **RTL Bridge / TCP**

Under **Mode** select **Stand Alone**, though later this may be changed to **Server** modes when everything is running properly.

Click **Start**.

The chart should automatically get the proper frequency range from RTL Bridge and label the Y axis accordingly. The number of channels will also be detected. The chart should begin accepting spectral info from RTL Bridge.

## Using RTL Bridge with Radio-SkyPipe

Radio-SkyPipe (RSP) uses its UDS channel to read data from RTL Bridge. UDS is a user definable data source that allows you to feed RSP from almost any device that has a software component that uses the UDS Model. You can read more about UDS here. In this case the UDS interface is part of RTL Bridge.

Unlike RSS, RSP is not required to reside on the same PC as RTL Bridge and the RTL dongle receiver. You can connect RSP to RTL Bridge over your LAN connection. The key requirement is that the network connection settings in RSP and RTL Bridge must match! If you use DHCP on your LAN and do not assign fixed IP addresses to the RSP and RTL Bridge PCs then your settings will fail when either of the PCs are assigned new addresses by the DHCP router. Of course, this is not a problem when RSP and RTL Bridge reside on the same PC. In that case it is best to just use the loop-back address (127.0.0.1) and a unused port for communication between the two applications.

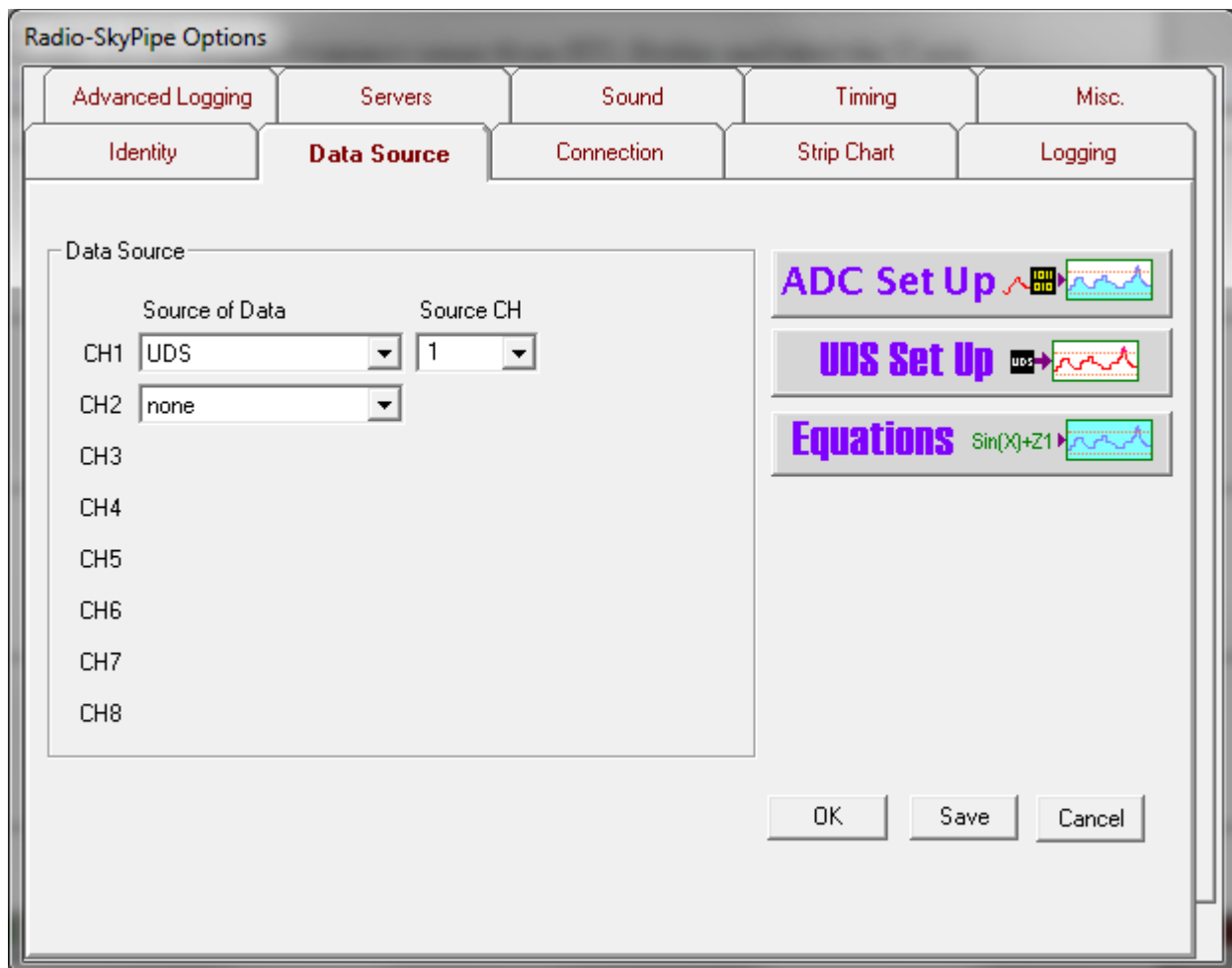
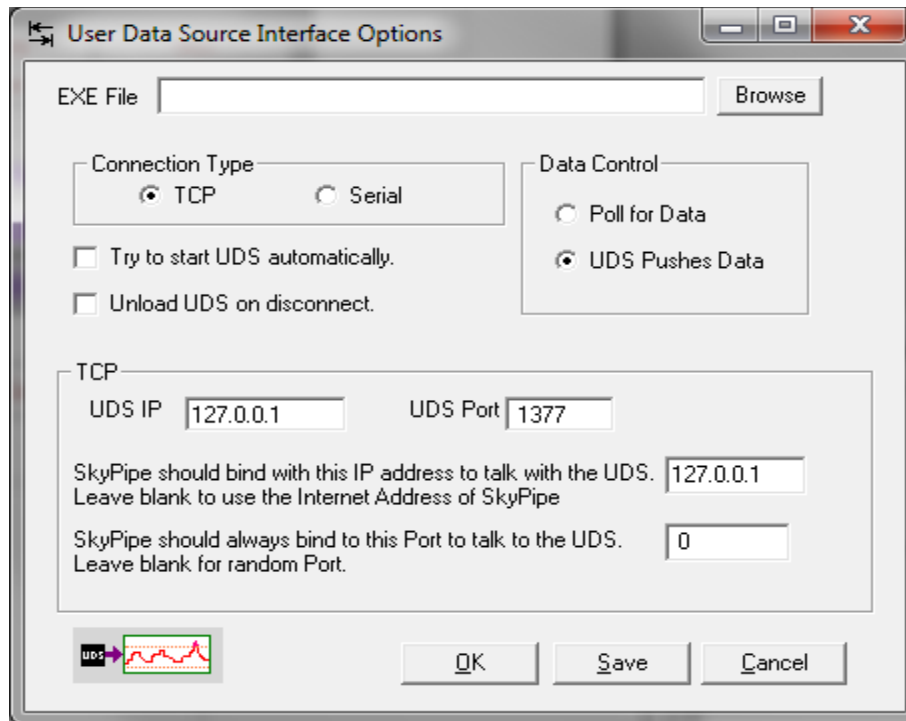

Illustration 38: The Options / Data Source configuration window in Radio-SkyPipe.

In RSS go to **Options / Data Source** and set the **Source of Data** to UDS as shown below.

Click on the **UDS Set Up** button. In the **User Data Source Interface Options** panel set the options as shown below:



*Illustration 39: UDS configuration window in Radio-SkyPipe.*

- **EXE File** is blank.
- **Try to start UDS** automatically is unchecked.
- **Unload UDS on disconnect** is unchecked.'
- The **UDS Pushes Data** option is selected in the **DataControl** box.
- In the **TCP** box use the same settings used in the RTLBridge settings for RSP.

If RSP is on the same PC as RTL Bridge then both will use 127.0.0.1 as the IP address.

**Save** and click **OK**.

Run RTL Bridge as described above.

Press the **Start Chart** button and RSP should begin the initial exchanges with the UDS server within RTL Bridge. Soon the chart should begin displaying the relative total power in the spectrum returned from the RTL dongle receiver. The numbers graphed are NOT calibrated at this point and will only be so when you use a calibrated noise source to feed the dongle and create a function to convert the raw value into a power measurement, probably antenna temperature.

*Timestamps for the incoming spectra will be created in RSP so it is important that the system clock on the RSP PC be accurate.*



## SDRPlay2RSS

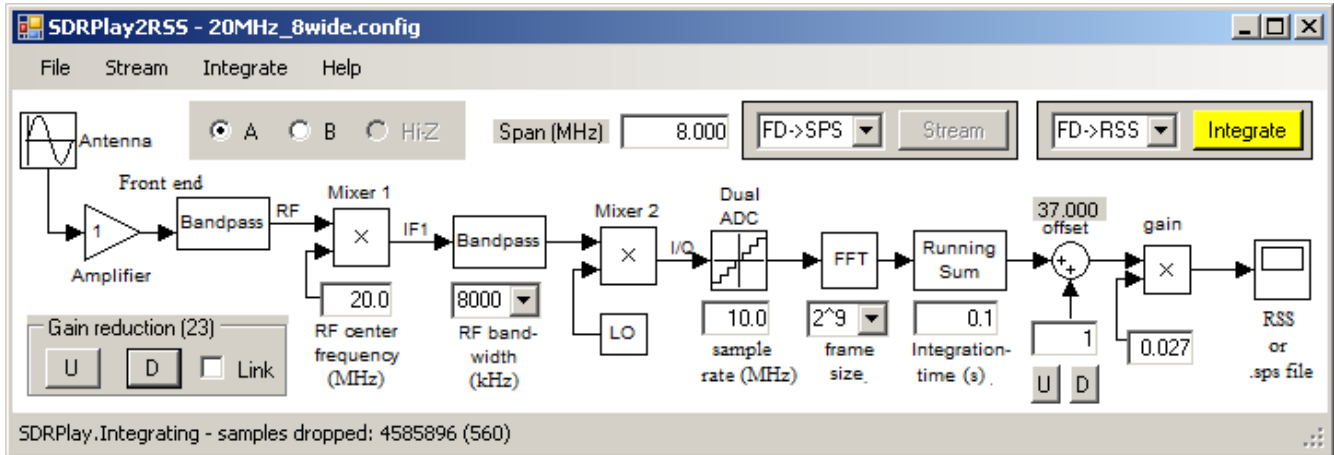

Illustration 40: SDRPlay2RSS application. The yellow Integrate button indicates the active connection with the SDRPlay receiver.

SDRPlay2RSS is a program written by Nathan Towne that allows you to use the SDRPlay line of software defined radios (SDRs) with RSS. Nathan's program is provided with the full install if RSS. SDRPlay2RSS has its own help file found here. There are a few parameters that must be adjusted in SDRPlay2RSS in order to get the best combination of dynamic range and sensitivity. A user guide has been created to cover the configuration and workings of SDRPlay2RSS. We provide configuration files for SDRPlay 1A and SDRPlay2 model receivers. However, each installation will probably require some tweaking. It is very helpful to own a noise calibrator and step attenuator to tweak these adjustments. If you own an MK2 calibrator module, adjustments can be made easier by utilizing the automatic plotting of the attenuation level vs the ADC response.

A help file is available in the SDRPlay2RSS application, so the details will not be repeated here. I highly urge anyone who is going to use this application to acquaint themselves with Nathan's documentation. There is additional guidance in documents found on the [Spectrograph User's Group](#) web page.



## Some History

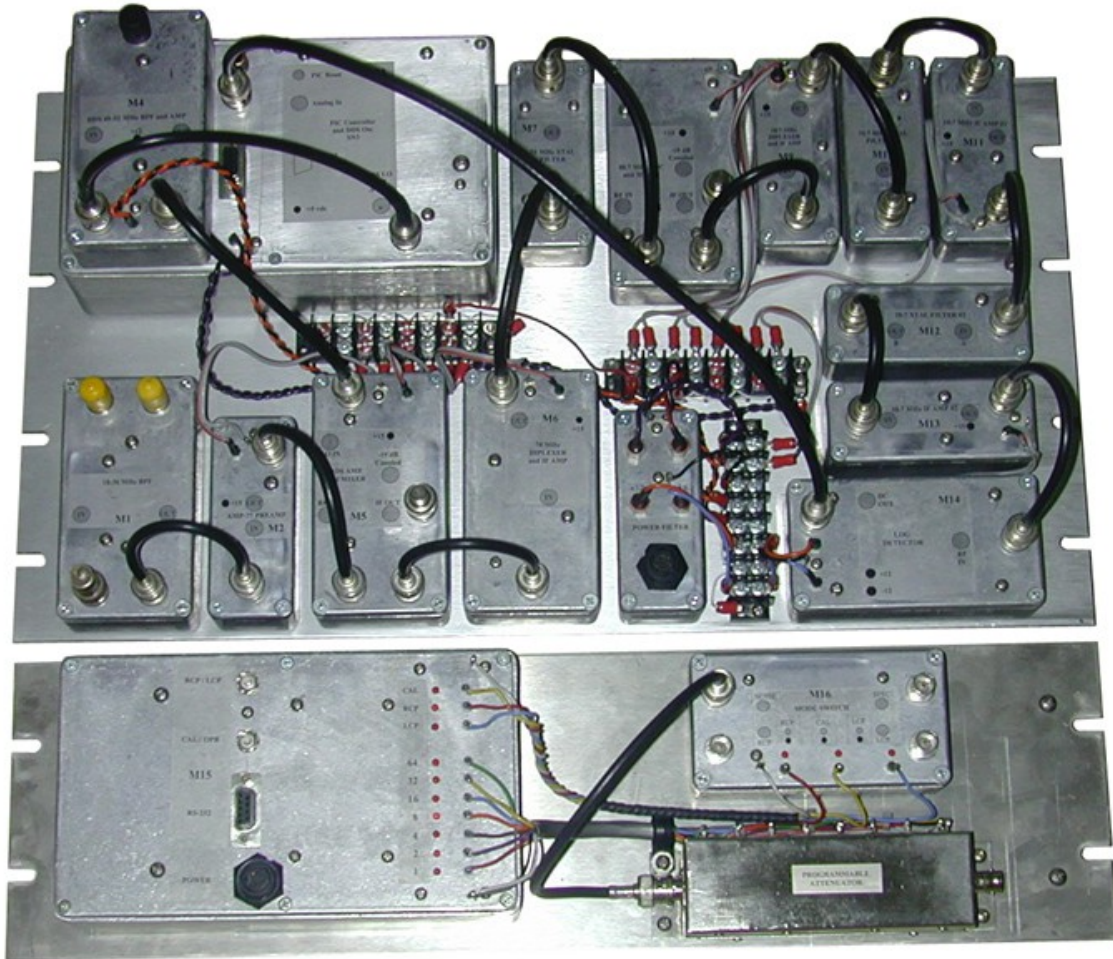

*Illustration 42: FS200B production model spectrograph with an automated step calibrator on the bottom panel. Everything can be controlled remotely via the serial port attached PC. From the front of the rack you just see an led, reset button, and perhaps a switch (can't remember). Basically, a DDS controls a receiver with a log detector. A micro-controller manages everything.*

Radio-Sky Spectrograph (RSS) is a free Windows program that displays radio spectra in a format that is easily saved and examined. The program got its start in 2001 as an experiment to create radio spectra data using an ICOM 8500 radio receiver at the Lanihuli radio observatory Windward Community Community on the island of Oahu in Hawaii. The original development of the program was supported by NASA via the Radio Jove Project. Soon we began supporting a series of custom made sweeping receivers that utilize a micro-controller and a direct digital synthesis (DDS) chip along with some well designed analog electronics by Richard Flagg of RF Associates. The first receiver in the series was the FS-200 which was installed at Lanihuli and also at the then extant University of Florida Radio Observatory. These receivers were limited to a fixed 200 channel width. Given the state of the

technology at the time, 200 channels gave a reasonable data rate that allowed us to see 50 kHz wide swaths of the 18 to 28 MHz at about 10 sweeps (spectra captures) per second. Both of these receivers are still in operation today.

The data storage convention in SPS files is from high frequency to low frequency. This reflects the fact that our sweeping receivers could to some extent follow Jupiter's S-bursts as they descended in frequency, giving a distinctive vertical signature. So as a result all data storage occurs in “sweeps” going from high frequency to low, even though there is no intrinsic reason to do that with spectral data created with FFTs.

The newer models of these sweeping receivers are the FSX - # receivers. Later models incorporated 12 bit ADC resolution and the number of channels was made flexible. Finally, the last major modification was the addition of a switching front end so that two antennas can be run from the same computer at the same time. This allowed us to see right and left hand polarized signals from the proper antennas. These receivers are listed as “switched” receivers in the RSS receiver list.

In 2014 I began looking at implementing Software Defined Radio (SDR) receivers in RSS. Many SDRs are available now (2019) for excellent prices and with amazing frequency ranges. The first really inexpensive SDR was the RTL dongle type, available for less than \$20. These receivers are still commonly used by amateur radio astronomers, and have even been used to detect pulsars (with a lot of care and tricks). I wrote an auxiliary program, RTL Bridge, to act as an intermediary between the RTL dongle receivers driver and RSS. Several [blog posts](#) refer to enhancements and spectrum stacking. More recently we have relied upon the help of other program to feed RSS data from the SDRPlay receivers using the same communication channel that we do with RTL Bridge.

## Annotations in Radio-Sky Spectrograph

Annotations are text labels that you can apply to any data point in the spectrogram. These notations are saved in comma separated values (CSV) file with the same base file name as the SPS data file but with the new ending “-Annotations.csv”. For example, a data file named 190606143000.sps would have an annotation file named “190606143000-Annotations.csv” placed in the same directory. When you load the data file into RSS, the program will look for the corresponding annotations file and load it if present.

To add an annotation to a file right-click on the spectrogram at the data point that you wish the annotation to correspond to. Select “Annotate” from the drop-down menu. You will then see a list of options similar to the one below.

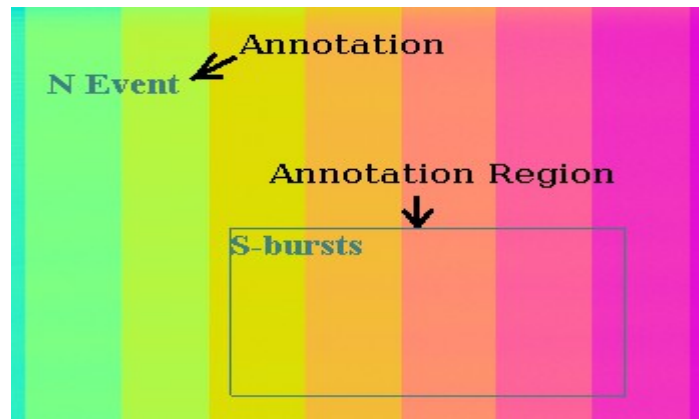

*Illustration 43: The customizable Annotate pop-up menu is accessed by right clicking on a loaded spectrogram and selecting Annotate or Annotate Region.*

The top portion of the list is a predefined list of notations that is kept in the RSS directory with the file name “Annotations.txt”. You may edit this list with notepad to add or remove these entries. This list should be limited to notations that you commonly use. The “CUSTOM” option allows you to type in a one time use notation of your choosing. That entry will not be added to the permanent list unless you do so manually. “CANCEL”, simply cancels this annotation.

## Annotate Region

This is similar to an ordinary annotation but pertains not to a single point on the spectrogram, but rather to a range of frequencies and times. You must draw a rectangular region with the mouse onto the spectrogram after selecting or entering the new annotation.



*Illustration 44: Annotations are text fields tied to specific points in a spectrogram. An Annotation Region includes a box defining the boundaries if the area of interest.*

## Find Slope Between Points

Some radio signals change frequency over time and the rate of change displayed can be useful in deducing the nature of the source of the signal. This software tool allows you to calculate the rate of change in kilohertz per second by drawing a line between two points on the display.

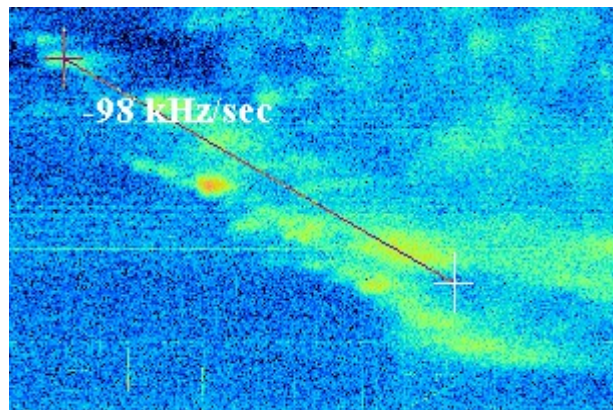

*Illustration 45: The Slope tool determines the drift rate of spectrogram features.*

Right-click on the point where you want to begin the measurement and select “**Find Slope Between Points**”. Then move the mouse cursor to the second point defining the feature and left-click. The slope will be calculated and displayed. Slope measurements may be saved with other annotations.

To keep track of the annotations of for any RSS data file, there is the **Spectrogram Annotations** window which appears whenever you add an annotation.

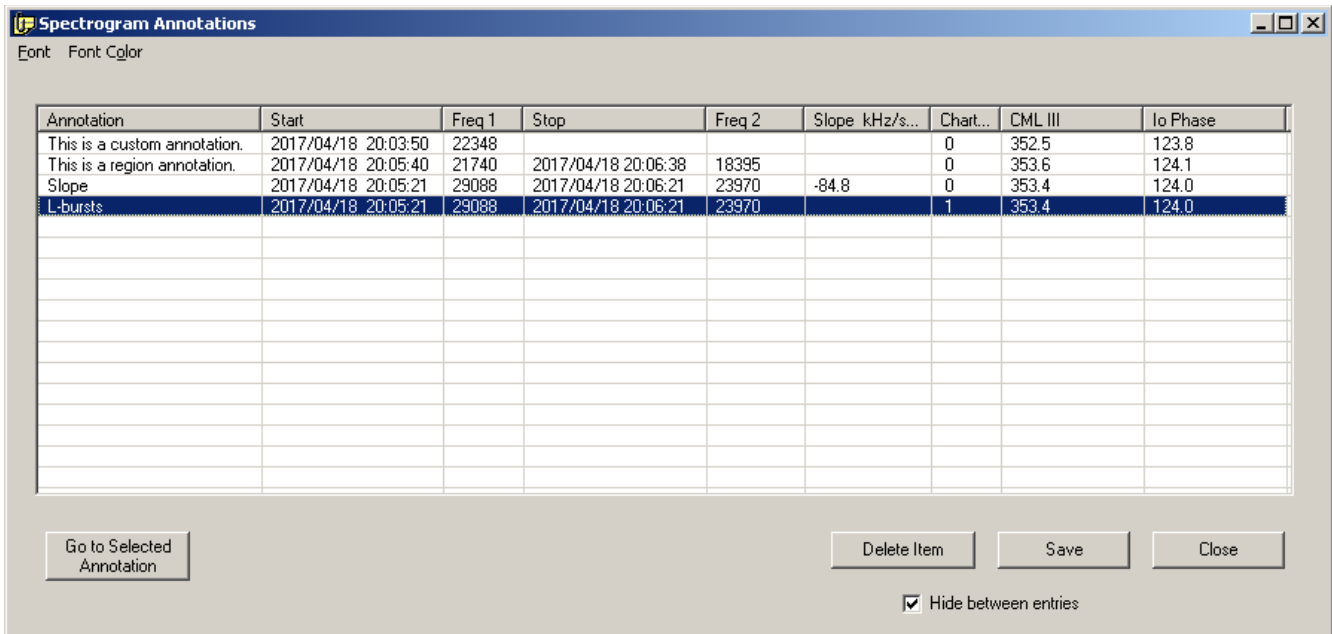

Illustration 46: Access the Spectrogram Annotations window under View / Show Annotations Window.

The **Spectrogram Annotations window** allows you to see all annotations attributed to the loaded file. In the example above, four annotations have been created in the currently loaded data file. The text associated with each annotation appears in the leftmost column, followed by the time and frequency associated with the text. If a region annotation or slope annotation is being displayed, then a second time and frequency are given. Slope annotations have their own column with the numerical value of the slope in kHz/second. The **Chart** column attaches the annotation to the upper display (0) or lower display (1). This is used in dual receiver spectrograms. Single receiver spectrograms will always appear in chart 0.

If you are running [Radio-Jupiter Pro](#) while adding annotations, and you have turned on the [Jupiter Information Server](#), then you may automatically record the CMLIII (Jupiter's central meridian longitude in System III) as well as the Io orbital phase. These two parameters are important in many studies of Jupiter's radio emissions.

Your editing options are limited to adding new annotations and using the **Delete** button to delete the selected annotation. You cannot modify an annotation once it has been added. You must delete and replace it.

Clicking the **Save** button will save the current annotation list with a file name relating it to the loaded data file. *This will overwrite any annotation file with the same name.*

Use the **Hide between entries** checkbox to keep this window out of the way when entering multiple annotations.

When you click the **Close** button you will be given the option to save these annotations if you have added or deleted annotations.

**Go to Selected Annotation** is a powerful button that allows you to quickly navigate to a given

annotation in the spectrogram. This could be very useful to researchers.



### ***The Importance of Metadata***

To help make the RSS data more scientifically useful, recent work has been towards increasing the scope of metadata included in the SPS data files and making them ready for conversion to the NASA CDF format for scientific archiving. This leads to an important point. You may use this program free of charge for any project you wish, but if you are collecting data pertinent to the Radio JOVE project, it is important to use the best operational practices to achieve useful scientific data. Central to this is inclusion of current and accurate metadata. Metadata is the information that gives your data context. Without it, the data is at most a pretty picture. Some metadata is automatically captured such as the number of discrete frequency “channels”. Some metadata such as your location, name, and observatory will probably never change, however, antennas change fairly often to accommodate the changing declinations of the Sun and Jupiter, and also for reasons of experimentation or improvement. So hang a sign over your most looked upon object to remind you to update these fields whenever you make these changes in the physical world.

### ***The Importance of Timing.***

It is very important that the times attributed to the samples are as accurate as possible. I am sure you are aware that computer clocks drift up to seconds per day. RSS includes a tool, the **SNTP Client**, more casually called the **Atomic Clock** in the menu. You should use this tool, even if you have some other Internet system clock updater running. It will verify in your metadata that you are using an accurate clock.

## Setting RSS to Run as Administrator

Version prior to 2.9.63 required that the program be manually set to *Run As Administrator*.

RSS should run on any Windows version from Xp to Windows 11. In Windows 7 and above it run RSS “*As Administrator*”. There may be many ways to set the program to run as administrator, but the following method works.

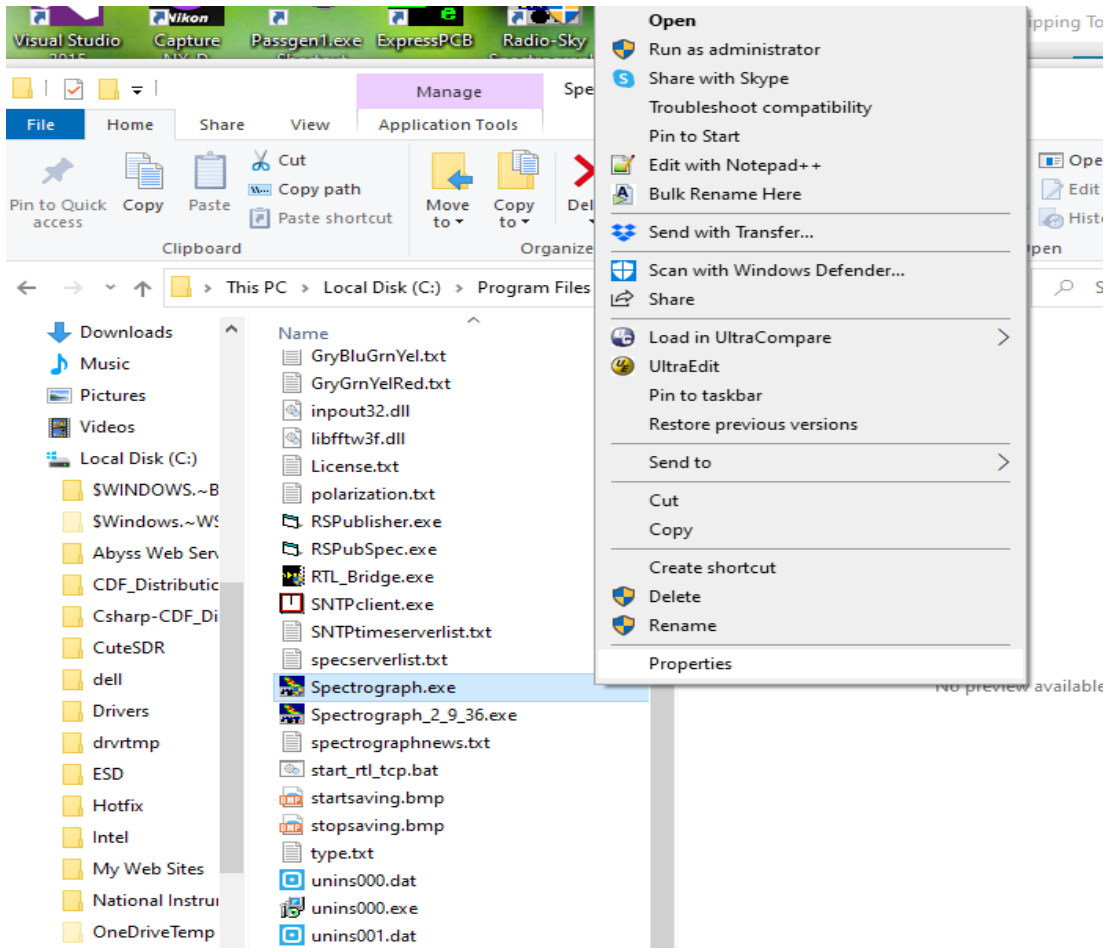

In File Explorer navigate to the **Spectrograph.exe** file located in the

*C:\Program Files (x86)\Spectrograph\*

folder. Right click on *Spectrograph.exe* and then select *Properties* in the drop-down menu. In the Spectrograph.exe Properties window click the **Compatibility** tab and check the box labeled “*Run as Administrator*”. Notice that while on this panel in Windows 10, I selected *Run this program in compatibility mode* for Windows Xp (Service Pack 2). This is not necessary unless you find the program misbehaves without compatibility mode set..

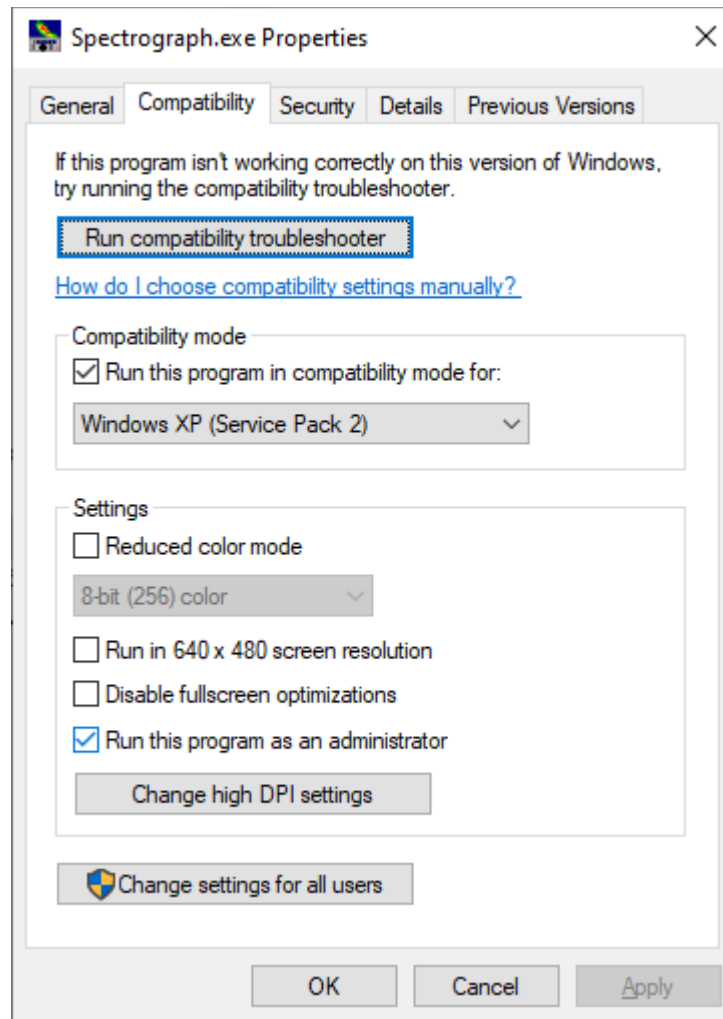

Clicking **OK** saves the setting.

## Saving Images in RSS

### Image Formats

Snapshot images may be saved in PNG or JPG image file formats. PNG images are preferred unless there is a need for smaller image file size. PNG images are larger but produce an image that more accurately reflects the original. To set the image format, go to Options / File Saving / Picture Format.

Note that versions before 2.9.64 also had the option to save in BMP format but this was discontinued because of the lack of the ability to include metadata in the BMP file format. The BMP format offers no advantage over PNG or JPG. If using an older version it is suggested that you do not use the BMP format.

### Image Saving Methods

Of course it is possible to take screenshots on your computer, or even take pictures with your phone, however these methods are inferior to the internal image saving methods.

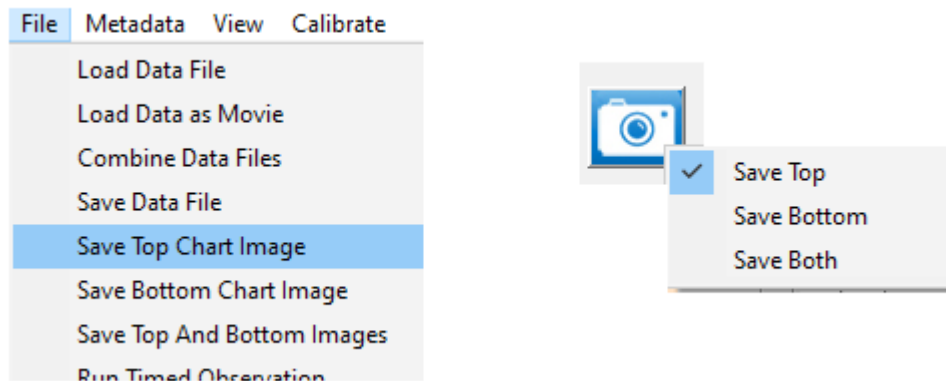

*Illustration 47: Two of the three image file capture methods. File Save image commands provide two click saving, while the camera button requires one click but must be configured. The third method is to just double-click the image.*

When you are actively collecting data, it is important not to interrupt the flow of the program or data may be lost. So whenever data is being collected, you are not given the option to choose where you want to save the image file. In this, state the image will be saved in the automatically generated folder for the observation data file.

Three methods are available to cause an image of a spectrogram to be saved to file.

1. Use the *File / Save Top Chart Image*, *Save Bottom Chart Image*, and *Save Top and Bottom Images*. These options work as you would expect, and save the corresponding images in the default file format that you have selected.
2. Simply double click on the image you want to save. You won't be able to save both images simultaneously with this method.

- Use the camera button. Using the camera button means that either the top, bottom, or both images will be saved based upon the camera button configuration. To configure the camera button, simply right click on it as shown in the illustration above. A single left-click saves the live image.

## Embedded Metadata

Scientifically valuable images must have their context documented. Information about the when, where, and how the image came into being and a description of its content can be embedded in some image file formats. Here we are using PNG and JPG formats both of which allow user defined fields to add text information. To read back the information requires software that can extract these text fields from the image files header. RSS can read and write this information which we can refer to as “metadata”.

The writing occurs automatically whenever you use one of the RSS internal methods (above) for saving a spectral image. To read the metadata you need to be in [Stand Alone](#) mode and select *File /Review PNG/JPG Comment*. Select the image file from the appropriate directory and a window will appear:

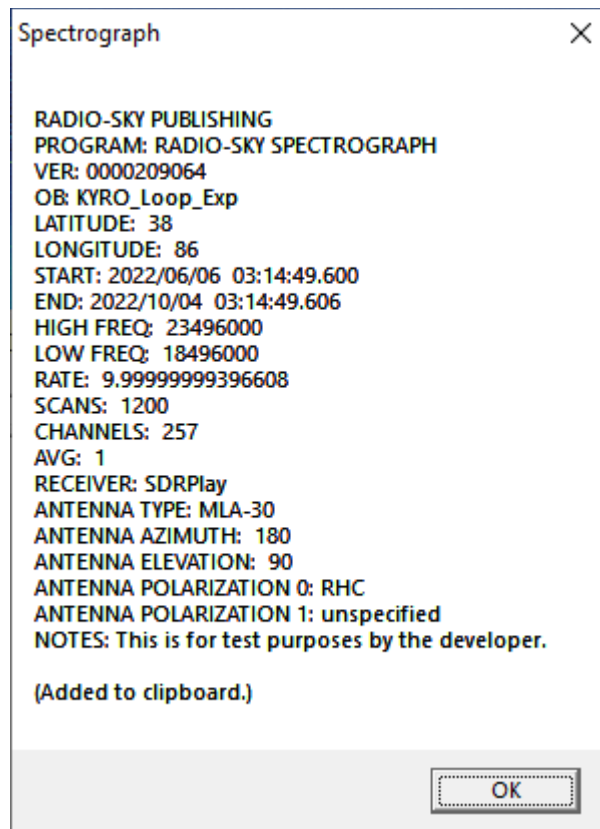

*Illustration 48: Image embedded metadata. Note that the text is automatically copied to the clipboard.*

## **Using RSS Image Files in Comparisons.**

RSS created image files can be shared to make quick comparisons between observers. Let's say observer X takes snapshots of three events they detected on June first and shares the images on groups dot io or via an email. You would like to see if you detected any of these events, so you load your corresponding June first 24 hour file and select File / Review PNG/JPG Comment and test each of X's three image files. Your spectral display will automatically adjust to the corresponding time frame in X's image. Having images cover the same time span eases visual comparisons. Now if you want to share back your corresponding snapshots you can just use the camera button or double click to save your version.

## SPS File Recovery

If the data file was interrupted while it was being collected, a SPS file might not be present. In that case you can likely recover the data from the temporary SPT file and its associated SPH header file. These temporary files are written while the program executes and are normally combined with a final timestamp when the observation ends into the SPS data file. After the SPS file is created, the SPH and SPT files are automatically deleted. A computer or program crash disrupts this finalizing process.

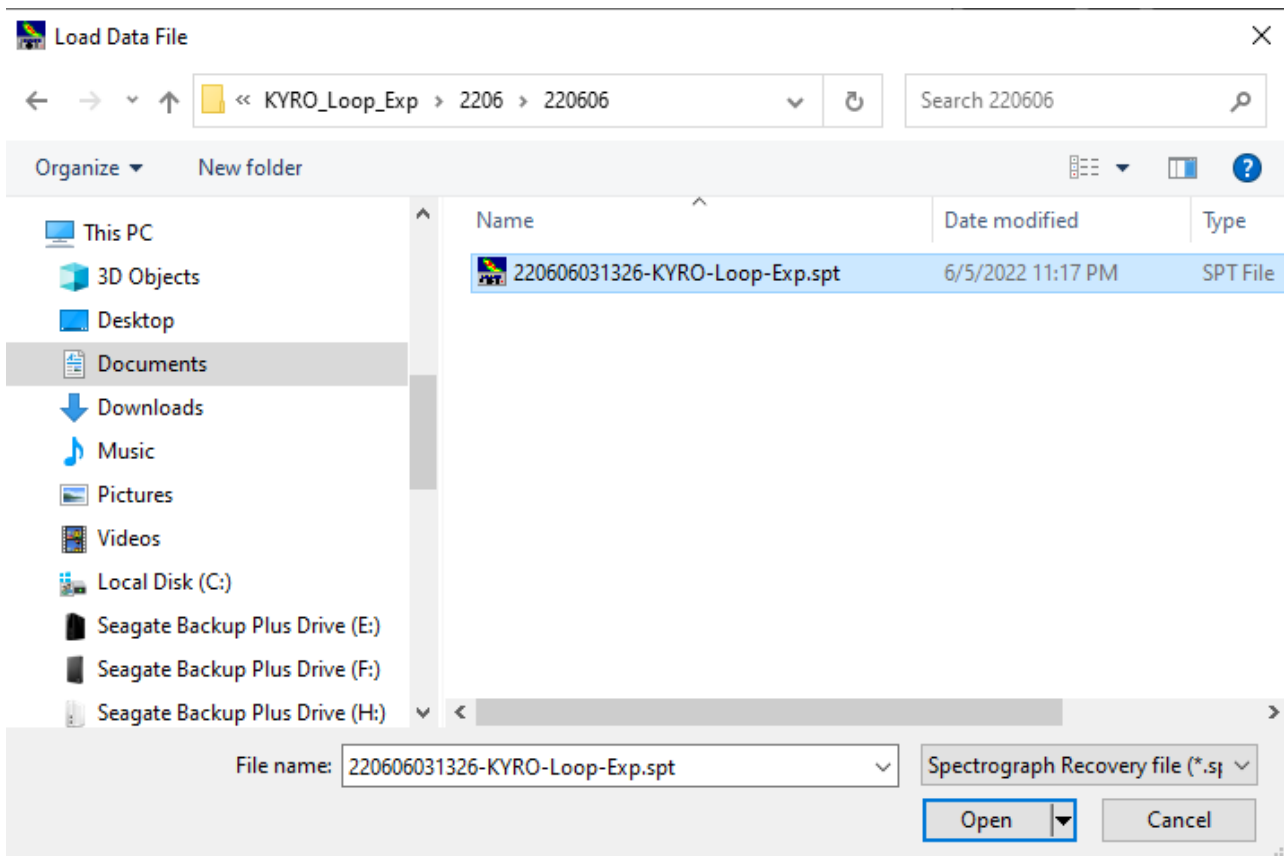

If you find that an expected SPS file is missing, look to see if there is a SPT and SPH file in the data directory folder for the observation. Use the Load Data file menu option in RSS and change the target file extension to “\*.spt”. Load the SPT file into RSS. You will receive a warning that the covered file does not have a recorded end time or sample rate. Click OK.

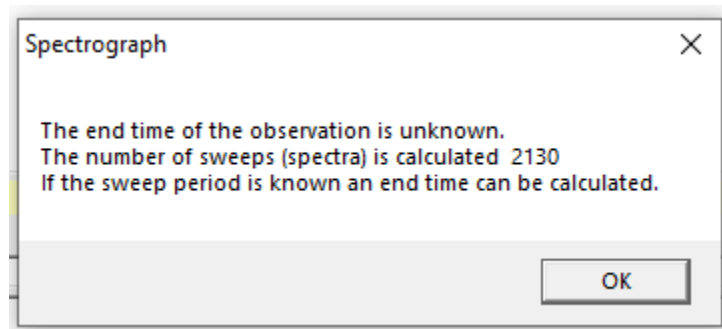

Now the *Edit Spectrograph File Header* window will appear, giving you an opportunity to provide the missing data. Prominently missing is the ending date and time of the observation. Also missing is the Rate in sweeps or spectra per second. If you know either of these values you can click the Edit button and enter the value. The other value will be calculated and the file will be saved as an SPS file.

A better option, if you have not changed your settings recently, is to click the Template button and point to a recent data file that should contain the same sweep rate and other metadata. This will also recover some of the antenna and banner information. Once you select the template data file and click OK the rest of the recovery is automatic, including deletion of the SPH and SPT files.



**Edit Spectrograph File Header**

Year Mo Day Hour Minute Second  
 Start 2022 06 06 03 13 26  
 Finish [Yellow]

Version: 0000209064 High Freq: 23.496  
 Author: Jim Sky Low Freq: 18.496  
 Observatory: KYRD\_Loop\_Exp Channels: 257 Single  
 Latitude: 38 Number of Sweeps: 2130  
 Longitude: 86 Duration  
 Location: Kentucky Rate [Yellow] sweeps/sec  
 Receiver: SDRPlay

Notes:

Antenna  
 Description: unspecified  
 Beam Azimuth: 0 Beam Elevation: 0  
 Polarization 1: unspecified  
 Polarization 2: unspecified

Template  
 Edit  
 OK  
 Cancel

Banner Top  
 Banner Bottom

220606031326-KYRD-Loop-Exp.spt

Enter Date/Time or  
sweep rate.

OR

**better!**

Select another data  
file with the same  
rate using Template.

*Illustration 49: Methods to fix a recovered SPT file.*

## Server Network Configuration

In order to successfully serve your live spectrograms over the internet with other RSS users, you must configure your router for port forwarding and remove any Windows firewall blocks to RSS. The information here is only of the most general type. You will have to consult the documentation associated with your particular router for directions on how to access the router configuration screens. Usually, this is done using a browser on your LAN. Google your router's make and model number or go to the manufacturers website and retrieve a manual if you don't already have one.

## Firewall Configuration

In later Windows versions the Windows Defender took over the roles of firewall and anti-virus protection. These comments refer only to Windows Defender. If you have additional anti-virus or firewall protection installed please refer to its documentation.

You probably will not have to do any real configuration other than to respond positively to the alert window that pops up the first time you run RSS in [Server Mode](#). When in this mode, RSS will attempt to open a network port on which to listen for incoming connection requests from other users who are operating RSS in [Client Mode](#). Windows will provide the following alert:

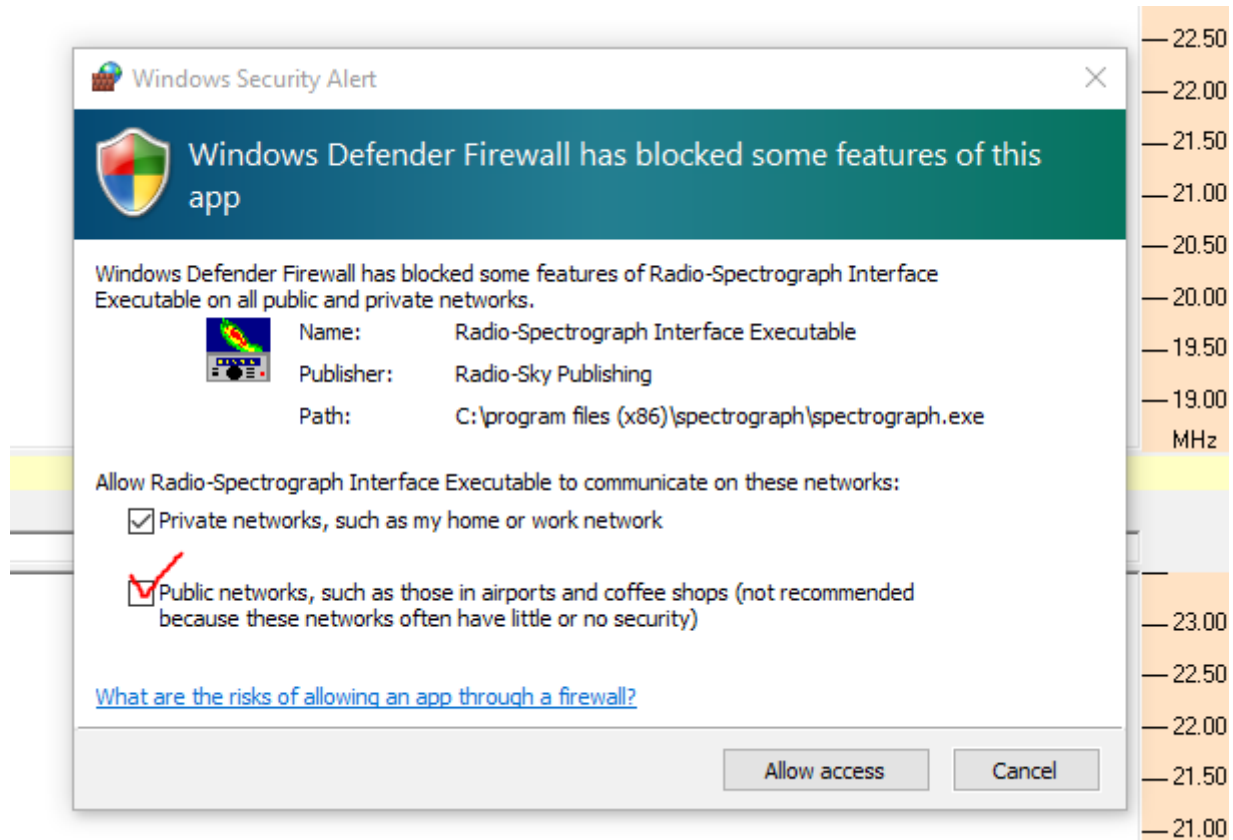

Make sure to check the *Public networks* box if you wish to allow people to connect to you from across the internet. Then click the *Allow access* button. If you freaked out and submitted it with only the

Private networks selected, you can fix it, starting with typing “firewall” and selecting Windows Defender Firewall. The following screen should appear:

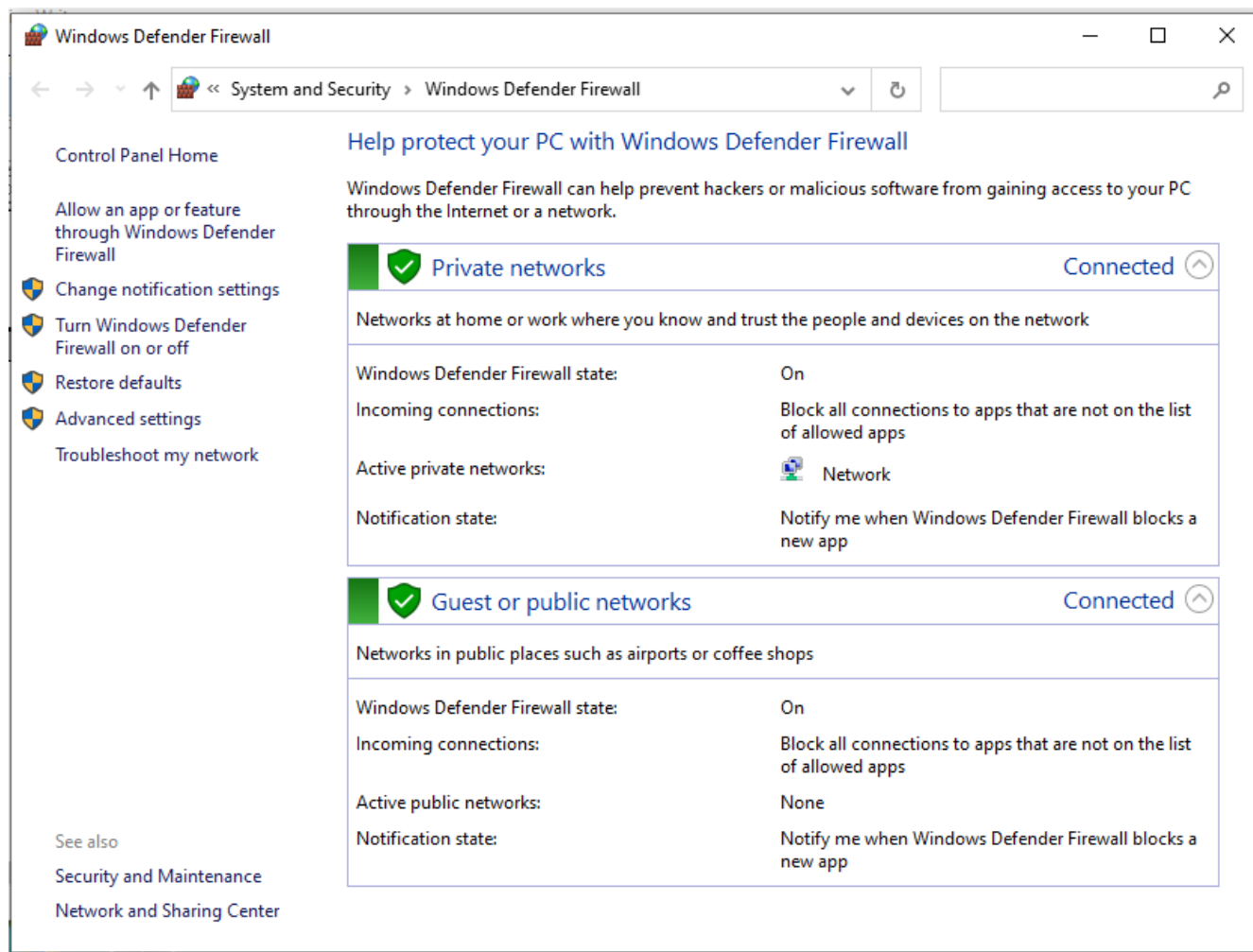

From here you can access “*Allow an app or feature through Windows Defender Firewall*”. A list of applications will appear from which you can edit the permissions or just delete the RSS entry and begin again.

## Router Configuration

The routers, among other things, are designed to keep unwelcome connection requests from reaching the network devices that reside in the protected space of your local area network. In this way the router acts similarly to the firewall software that filters any un-allowed network request even those from your own LAN from reaching your computer.

Routers use a system of Network Address Translation (NAT) to take information from the superhighway of the internet and make sure it gets sent to the right computer and the right program in that computer. You set up special rules in the router for special programs. This is often done in a configuration area dedicated to Port Forwarding, Forwarding, or something similar.

You will have to consult the documentation associated with your particular router for directions on how to access the router configuration screens. Usually, this is done using a browser on your LAN. Google your router's make and model number or go to the manufacturers website and retrieve a manual if you don't already have one.

Generally, you will log into the router interface, find the area dealing with port forwarding or special applications and set up the rules so that they match with the IP address and RSS port numbers of your RSS server. The configuration process requires that you know the computers LAN address. This can be dot address (like 192.168.1.100) or a computer name for a DHCP computer. You will also need the port number used by RSS, as set in the RSS Options/Network/Local Connection window:

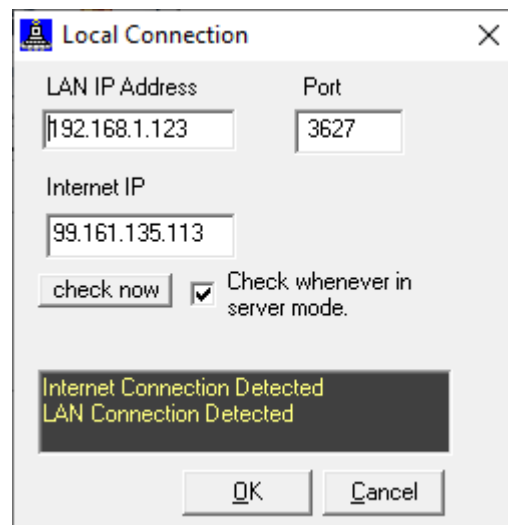

Here LAN address is 192.168.1.123 and the port is the default 3627 value. The port forwarding configuration panel will also want to know if the port will be using TCP or UDP protocols. Select TCP or TCP and UDP if that is the only option. As an example, my AT&T router requires visiting a tab called NAT/Gaming. I had to set up a custom "Service" (RSS) and then associate the service with a particular computer name.

Device Broadband Home Network Voice Firewall Diagnostics

Status Packet Filter **NAT/Gaming** Public Subnet Hosts IP Passthrough Firewall Advanced Security Options

Changes saved

### NAT/Gaming

---

#### Hosted Applications

Service	Ports	Device	Delete
Radio-SkyPipe	TCP/UDP: 6300-6302	Radio-Sky	Delete
Abyss Web Server	TCP/UDP: 6310-6312	Radio-Sky	Delete
RSS	TCP: 3627-3628	DESKTOP-VJ6Q9HQ	Delete

#### Application Hosting Entry

Service: \*Radio-Sky Spectrograph [Service Details](#)

Needed by Device: DESKTOP-VJ6Q9HQ

[Add](#)

---

#### Manage Custom Services

[Custom Services](#)

#### Help

NAT/Gaming allows you to have certain services forwarded directly from the Internet to a particular device. This is required for some Internet applications (e.g., online games, file exchange, communication programs, servers).

You can view the protocol/port assignments for a service by clicking "Service Details".

You can create custom services if your application or service is not listed.

Custom services created on this device are shown in the Service pulldown preceded by the \* character.

End of section.