



Station Description

02 Feb 2020

Dave Typinski

CONTENTS

Observatory Outline	1
TFD Array Schematic	4
TFD Array Feed Losses	5
TFD Array Element S_{11} and Pattern	6
Antenna Test Range Feed Schematic	7
RF Surge Suppressors	8
Antenna Feed Control	9
Receivers	10
Calibration Temperatures	11
Power Distribution	13
Ethernet Diagram	14
TFD Array Beam Steering	15
Terrestrial Beam Heading Map	21
Magnetic Declination	22
Facility Layout	23
Location Within North America	24



26211 W US Hwy 27
PO Box 2423
High Springs, FL 32655

Contact: Dave Typinski
davetyp@typnet.net
(386)344-3166

OBSERVATORY OUTLINE

Location

29° 50' 13" N	29.8369° N	EL89qu
82° 37' 17" W	82.6214° W	
53 ft (16 m) MSL		

Antennas

TFD Array

Two square arrays on a NS line, eight 30-foot TFD elements, beam steering in 5° increments NS and 15° increments EW.

16 MHz HPBW at zenith: 18° NS x 40° EW

20 MHz HPBW at zenith: 15° NS x 35° EW, D ≈ 14 dBic

24 MHz HPBW at zenith: 12° NS x 30° EW

32 MHz HPBW at zenith: 8° NS x 20° EW

For more about the TFD Array, see: [The DPS and TFD Array](#)

Antenna Test Range

Presently conducting galactic background measurement series with $\frac{1}{2}\lambda$ dipoles.

Receivers

Dual Polarization Spectrograph (DPS)

24 x 7 x 365 unattended operation

16–32 MHz, simultaneous (correlated) RCP and LCP

300 channels per polarization (600 total)

Swept frequency, selectable 7.5, 15, 30, 60 kHz pre-detection BW

~ 6.7 sweeps/sec, integration time = 500 μ s per sample

Frequency resolution = 53 kHz, $\Delta t = 150$ ms

For more about the DPS, see: [The DPS and TFD Array](#)

Receivers (cont'd)

Radio Jove Receivers

24 x 7 x 365 unattended operation
~ 20.1 MHz, uncorrelated RCP and LCP
7 kHz RF BW folded via direct conversion into a baseband
3.5 kHz pre-detection audio BW
Integration time = 100 ms per sample
For more about the Jove Receivers, See: [Radio Jove Receiver Manual](#)

Icom R8500 + 10.7 MHz Jove Receiver

7 kHz RF BW folded via direct conversion into a baseband
3.5 kHz pre-detection BW
Integration time = 100 ms per sample

Tunable Wideband Receiver (TWB) Mark III

Attended operation only
Tunable from 16 to 32 MHz, RCP or LCP
2 MHz IF BW direct to high speed digitizer
FFT post-processing, RBW = 4.88 kHz, $\Delta t = 205 \mu\text{s}$
For more about the TWB, see: [The TWB](#)

Icom R75 Receivers 1 & 2

Used as required for antenna test range operations.

Sensitivity

Formal sensitivity calculations and measurements have not been made. A rough estimate considering only the number of dipoles is a 20 MHz on-axis and at zenith 3σ sensitivity on the order of 100 kJy. All receivers presently in use have noise figures between 6 and 8 dB, making their internal noise of little concern given the modest losses between the TFD array and the receivers and the fact that in the upper HF band, system noise is dominated by the galactic background emission.

Timing

All radio telescope data collection systems use a PC's internal clock to apply time-stamps to the data. Each PC runs a service, Meinberg NTP daemon, to keep its system clock within a few milliseconds of UTC using Network Time Protocol (NTP). The NTP server is a GPS-ntp-pi stand-alone unit using GPS and GLONASS signals to determine and provide the correct time on the local network. Future work includes upgrading the spectrographs to a GPS-based hardware system with firmware modification to keep the start of each frequency sweep disciplined to within a hundred nanoseconds of UTC.

For more information, see: [GPS-NTP Pi](#)

For more information, see: [Meinberg NTP Server](#) and [Meinberg NTP Server Monitor](#)

Calibration

All radio telescope systems are calibrated in terms of antenna temperature using a noise source calibrated against a 5722 noise diode. An automatic calibrator runs a step calibration on all receivers. The step cal runs 17 steps each separated by 3 dB. Calibration timing, step duration, and noise temperature varies as required by telescope and test range operations. For more information see: [AJ4CO Automatic Calibrator](#)

Computers

Three identical PCs are used to record data from the receivers. Each has a 2.4 GHz AMD Opteron dual-core processor, 4 GB RAM, and a 1 TB hard drive. All run Windows XP SP3. All are connected to the observatory LAN.

Internet

The observatory has internet access via a 6 Mbps DSL connection. This connection allows the Radio Sky Pipe (RSS) and Radio Sky Spectrograph (RSS) software to serve data to interested remote observers.

Power

The receivers, computers, and network hardware are fed by six 1.5 kVA battery backup units providing at least 15 minutes of power if the AC mains fail.

Operations

Several radio telescopes operate all day, every day (see "Receivers" above). Useful Jupiter observations are made any time Jupiter is within 3 hours of transit, but this is extended to around 4.5 hours when Jupiter's transit elevation is greater than 70° and Jupiter is near opposition.

North

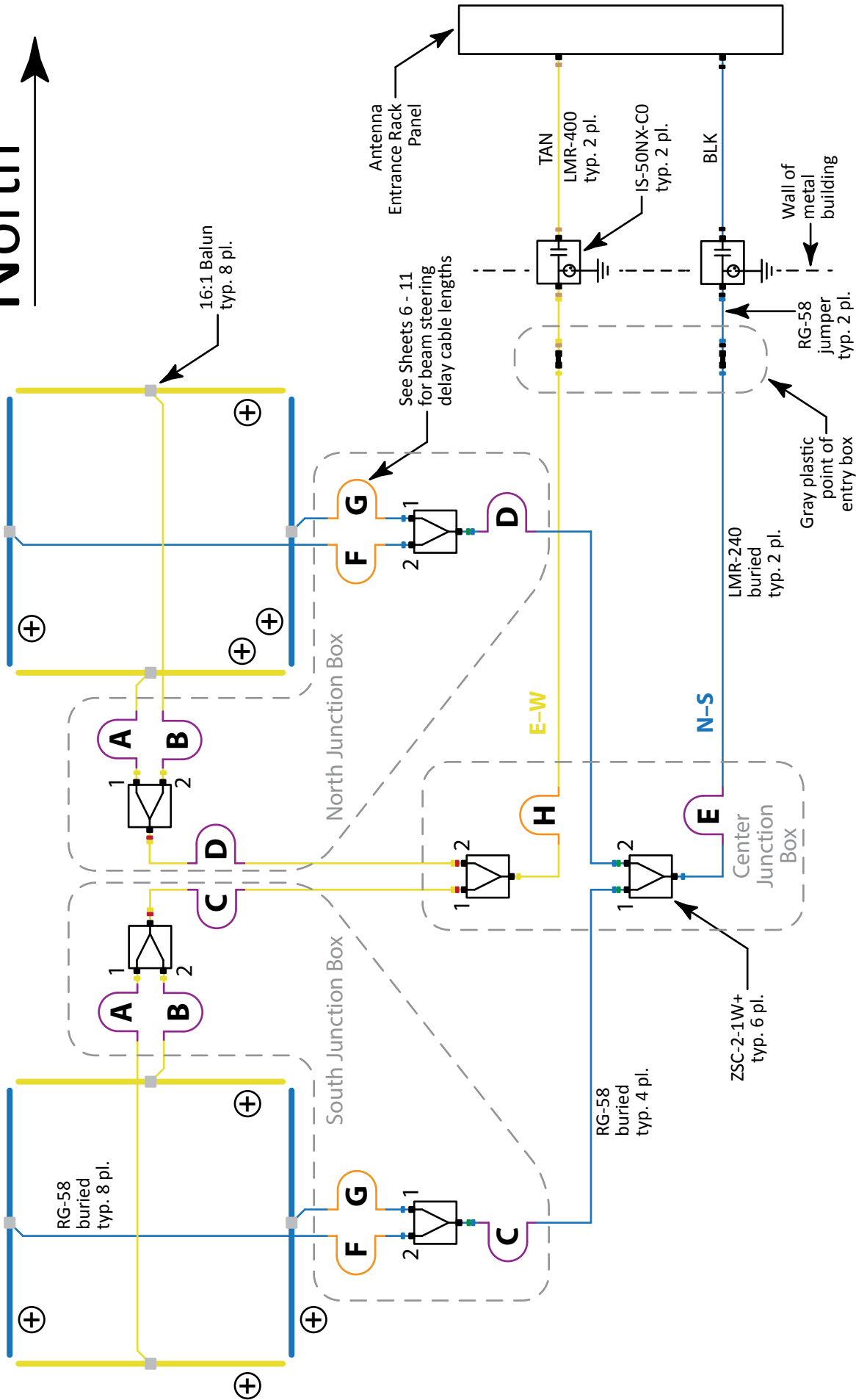

30' terminated folded dipoles, top wire 9'2" height,
 8" wire spacing, 32' element spacing,
 800 Ω termination resistors, 16:1 baluns.

TFD Array - Electrical



SIZE	DATE	PART NUMBER	REV
A	02 FEB 2020	N/A	B
SCALE	NONE	DRAWN BY	SHEET
		DAVE TYPINSKI	1 OF 1

30' TFD Element Feed Point (Balun Output) Characteristics Plots
 Measured above natural ground (no ground screen).

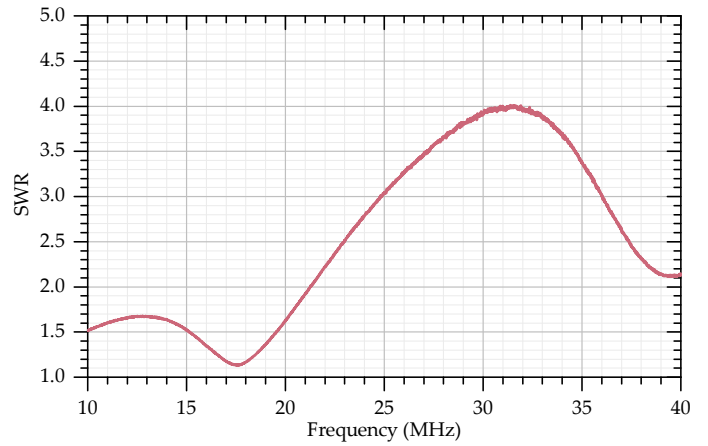
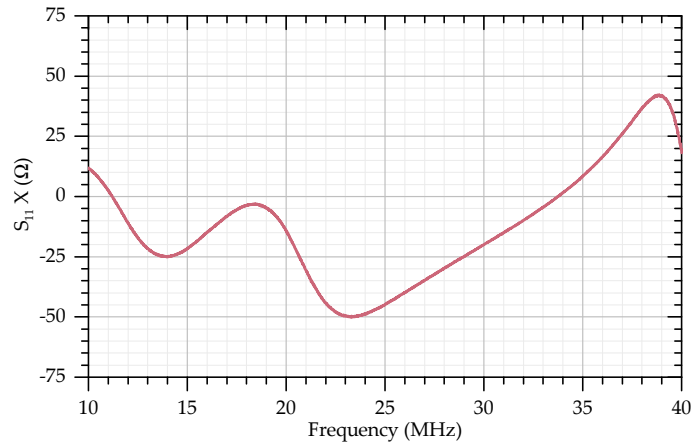
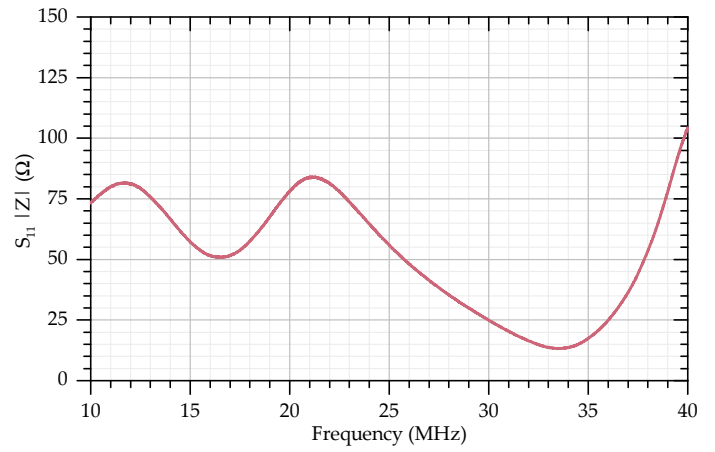
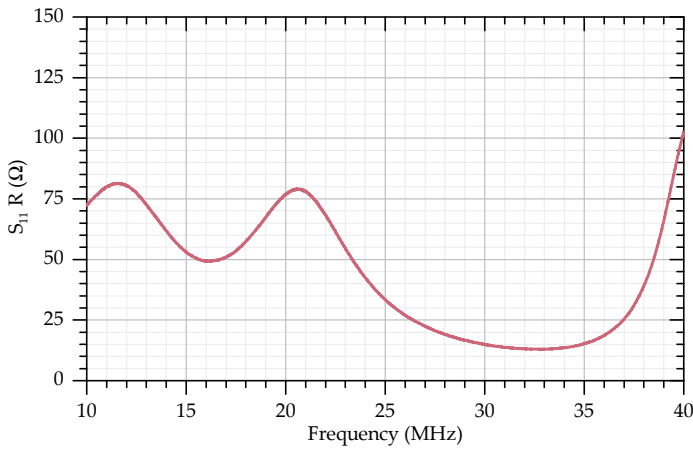

30' TFD 20.1 MHz EZNEC predicted element beam pattern
 Modeled above poor ground. Azimuth pattern at 45° elevation.

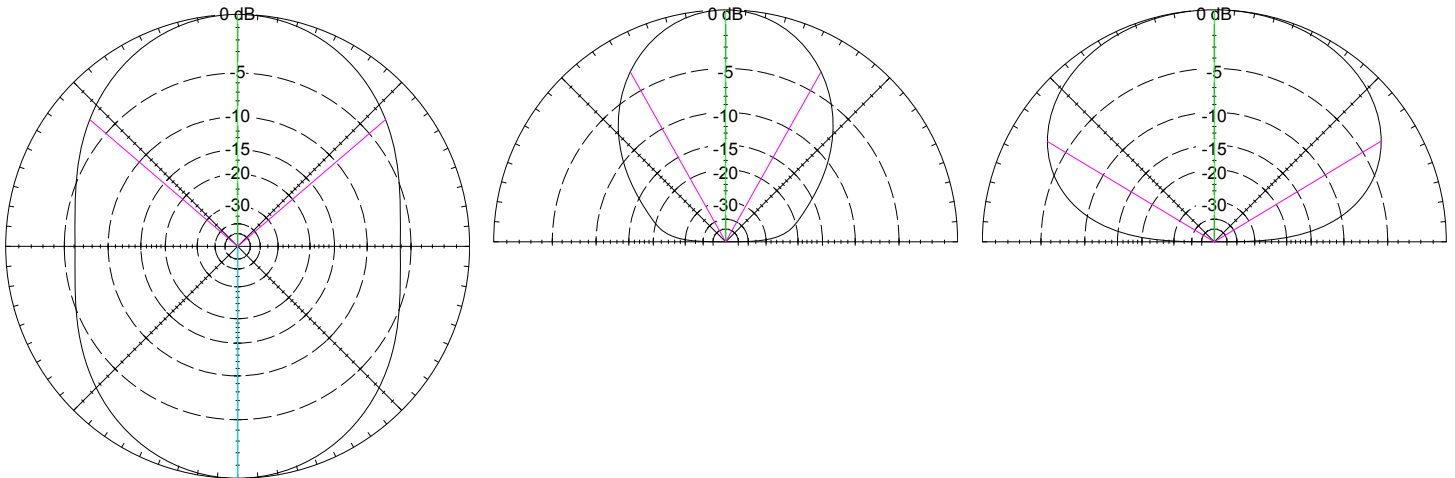

North

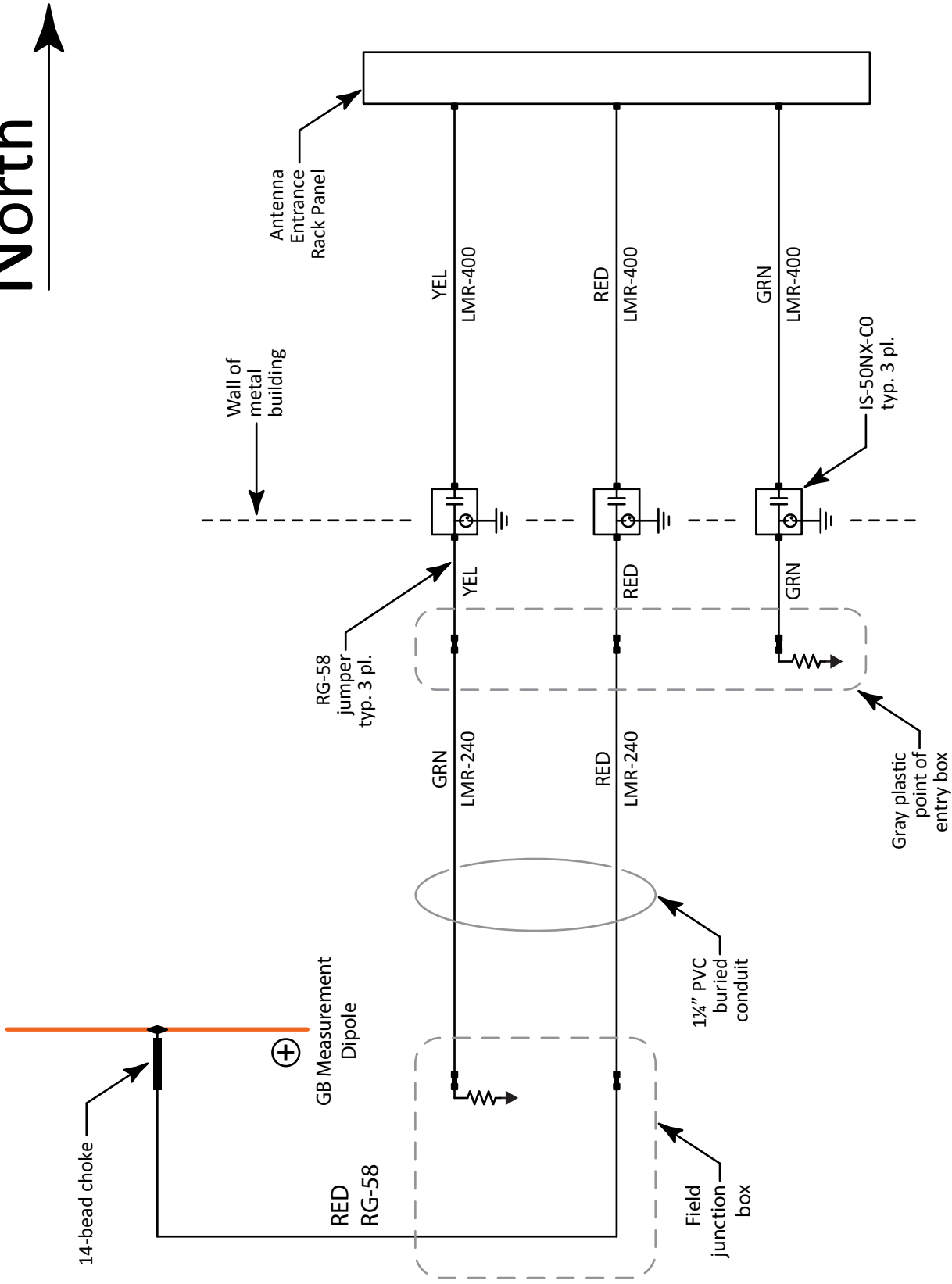

AJ4CO OBSERVATORY		Antenna Test Range - Electrical	
SIZE	DATE	PART NUMBER	REV
A	01 FEB 2020	N/A	C
SCALE	NONE	DRAWN BY	SHEET
		DAVE TYPINSKI	1 OF 1

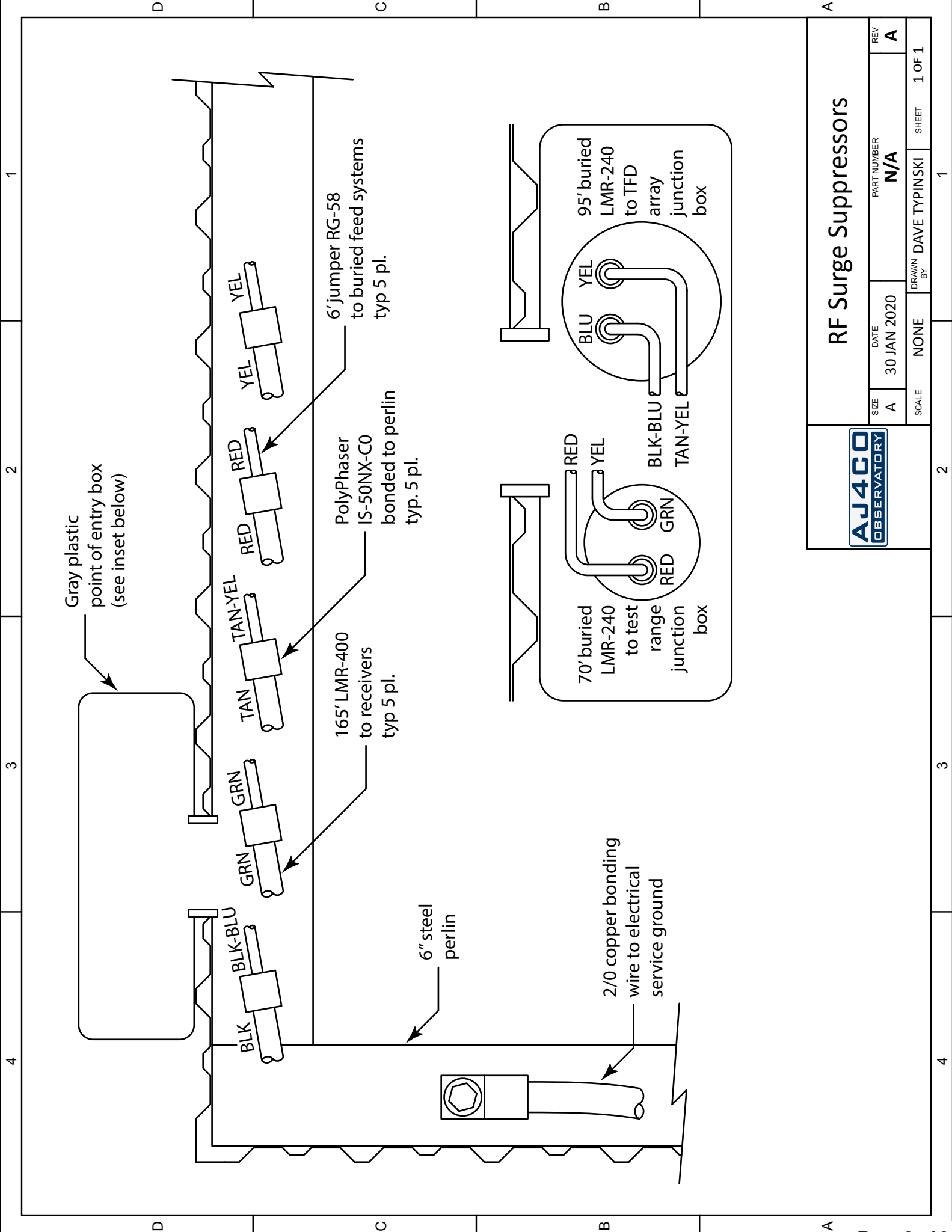

		<h2 style="text-align: center;">RF Surge Suppressors</h2>		REV	A
				DATE	30 JAN 2020
SIZE	A	PART NUMBER	N/A	DRAWN BY	DAVE TYPINSKI
SCALE	NONE	SHEET	1 OF 1		

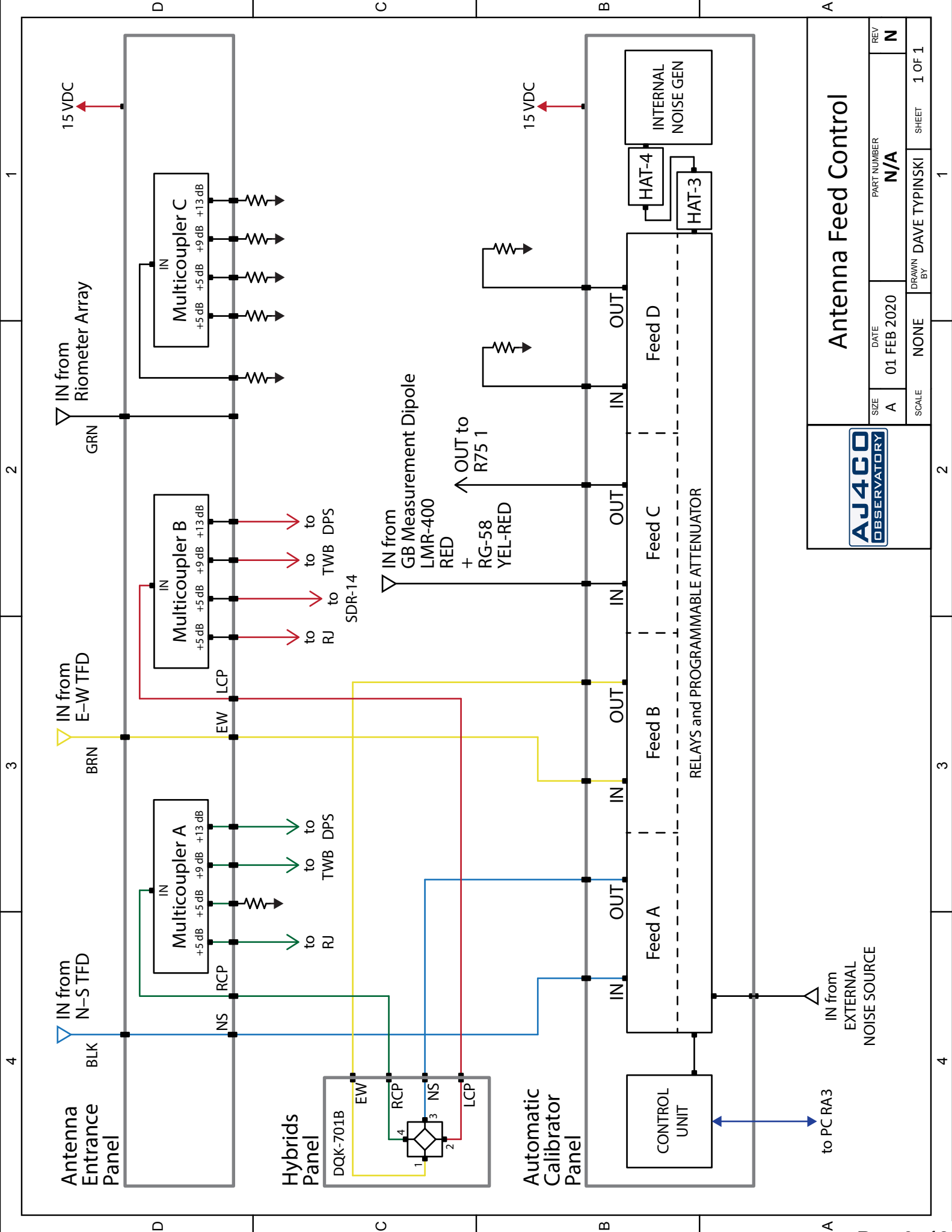

Antenna Feed Control		DATE	01 FEB 2020	PART NUMBER	N/A	REV	N
		SCALE	NONE	DRAWN BY	DAVE TYPINSKI	SHEET	1 OF 1

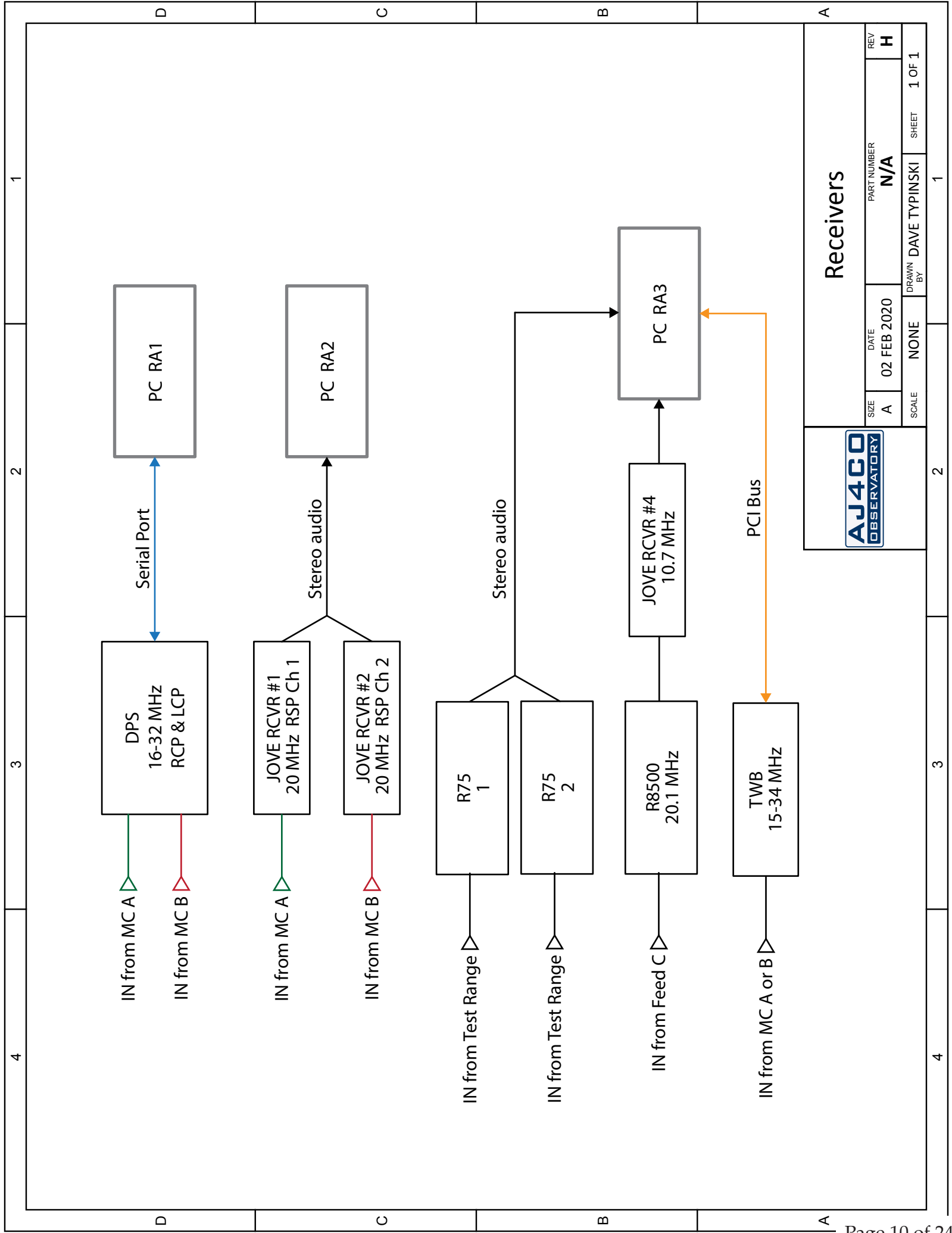

		DATE	02 FEB 2020	DRAWN BY	DAVE TYPINSKI	SHEET	1 OF 1
		SCALE	NONE	PART NUMBER	N/A	REV	H

Receivers

The AJ4CO automatic calibrator is presently modified by the addition of a HAT-4 and a HAT-3 in series at the internal noise generator's output connector. Plots below show the noise temperature and variation at the automatic calibrator front panel connectors (the calibration plane) during the calibrator's 0 dB attenuation step. The internal noise generator was measured at $430 \text{ MK} \pm 0.1 \text{ dB}$ on 05 Jan 2020.

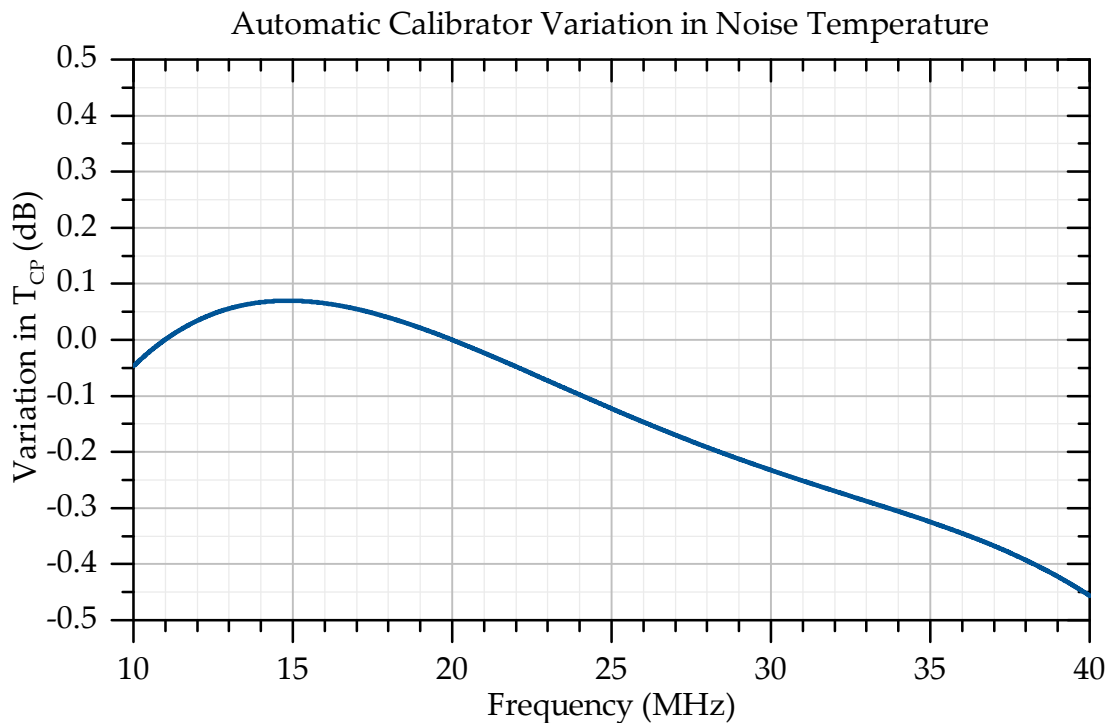
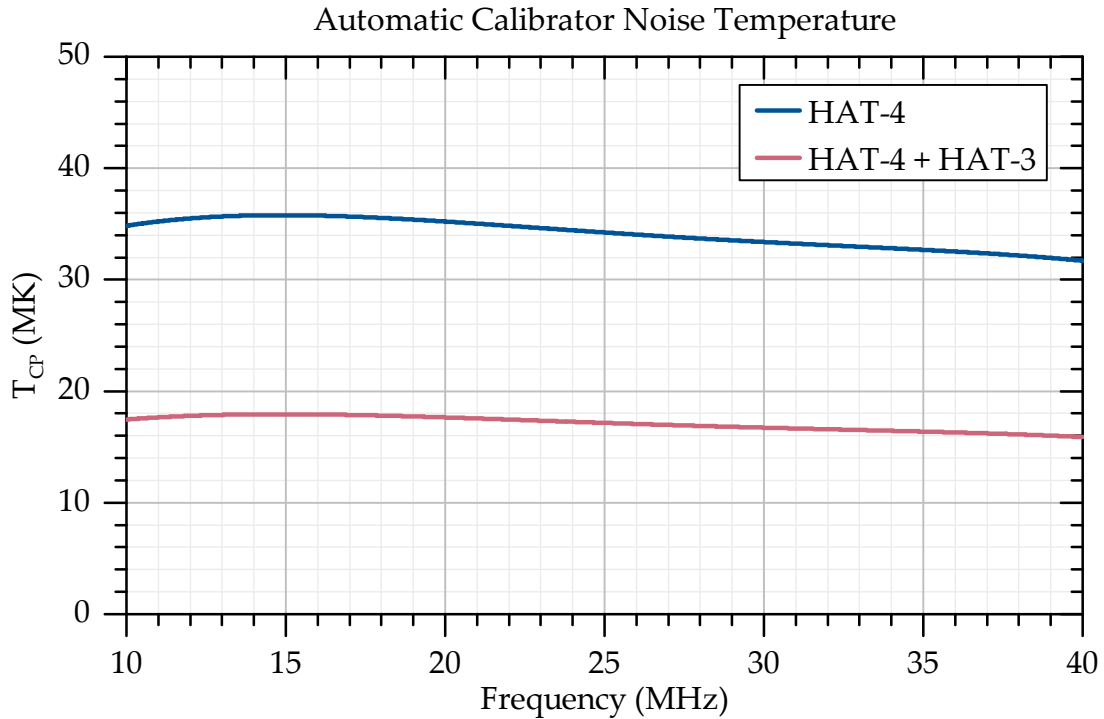

Automatic Calibrator Calibration Plane Noise Temperatures at 20 MHz
Internal Noise Generator Calibrated Against 5722 on 05 Jan 2020

T₀ (K) 290
Noise Source 20 MHz Temperature (MK) 430
Splitter 20 MHz Loss (dB) 13.4 (6.35 splitter + HAT-4 + HAT-3)

Calibration Plane: CAL relays between Antenna Feeds Entrance and Hybrid Ring Inputs.

Nominal Attn. (dB)	Measured Attn. @ 20 MHz (dB)	Cal Plane Tnoise (K)	Auto Cal Step	Nominal Attn. (dB)	Measured Attn. @ 20 MHz (dB)	Cal Plane Tnoise (K)
0	0.56	17.5 MK	1	0	0.56	17.5 MK
1	1.52	14.0 MK	2	3	3.43	9.03 MK
2	2.56	11.0 MK	3	6	6.47	4.48 MK
4	4.57	6.94 MK	4	9	9.45	2.26 MK
8	8.55	2.78 MK	5	12	12.58	1.10 MK
16	16.58	437 kK	6	15	15.48	563 kK
32	32.50	11.5 kK	7	18	18.55	278 kK
64	64.65	297 K	8	21	21.50	141 kK
			9	24	24.55	70.0 kK
			10	27	27.51	35.6 kK
			11	30	30.58	17.7 kK
			12	33	33.49	9.19 kK
			13	36	36.54	4.70 kK
			14	39	39.55	2.50 kK
			15	42	42.55	1.40 kK
			16	45	45.59	839 K
			17	48	48.55	568 K



Calibration Temperatures

SIZE A	DATE 02 FEB 2020	PART NUMBER N/A	REV E
SCALE NONE	DRAWN BY DAVE TYPINSKI	SHEET 1	OF 1

15 VDC Power Requirement

Equipment	Draw (mA)
Multicouplers	330
DPS Spectro	720
DPS IF Strips	570
Calibrator	980
TWB Rcvr	250
Jove Rcvrs	160
GPS-ntp-pi	120

Total: 3.1 Amps

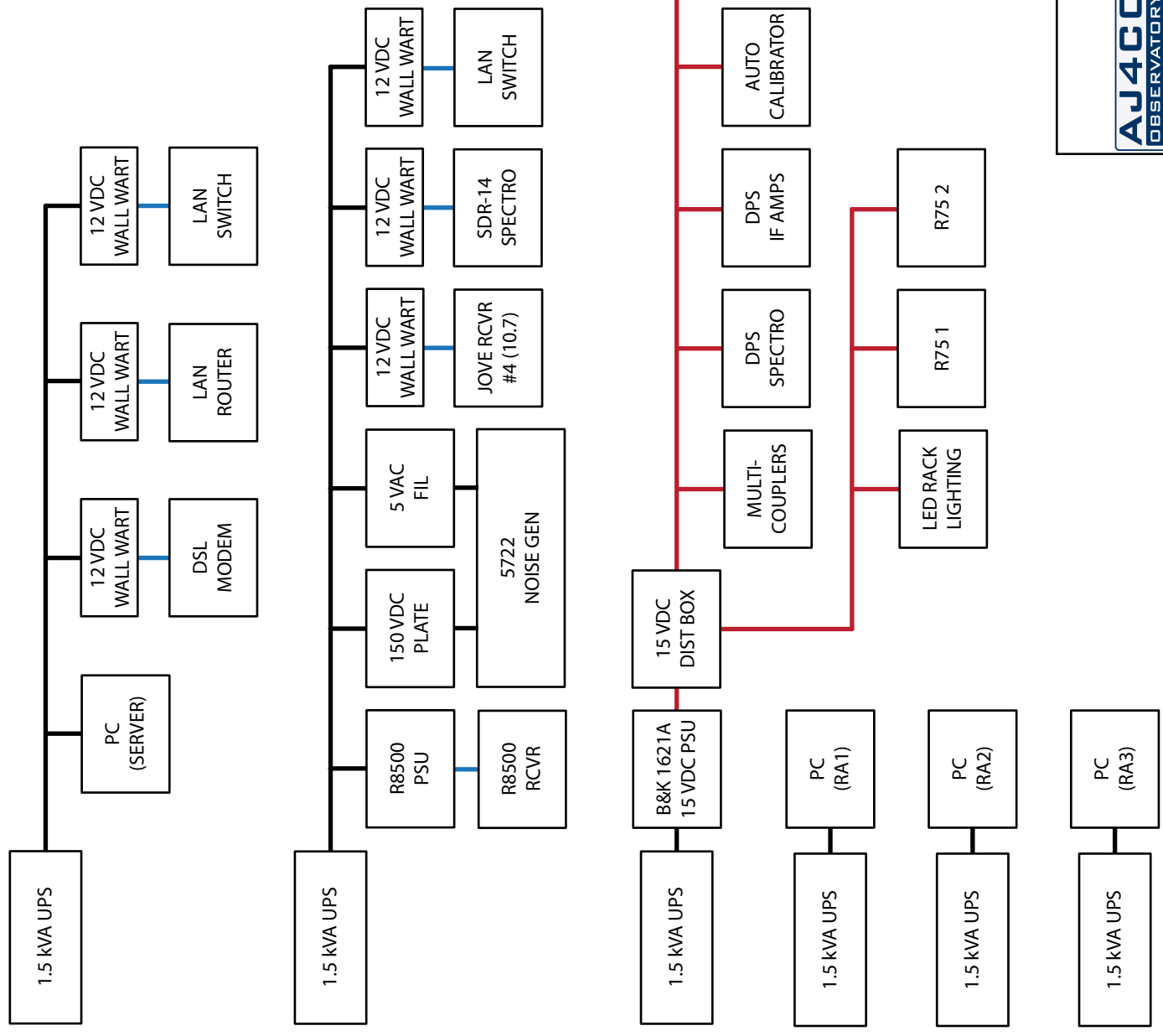

Power Distribution



SIZE	DATE	PART NUMBER	REV
A	29 NOV 2019	N/A	D
SCALE	DRAWN BY	SHEET	1 OF 1
NONE	DAVE TYPINSKI		

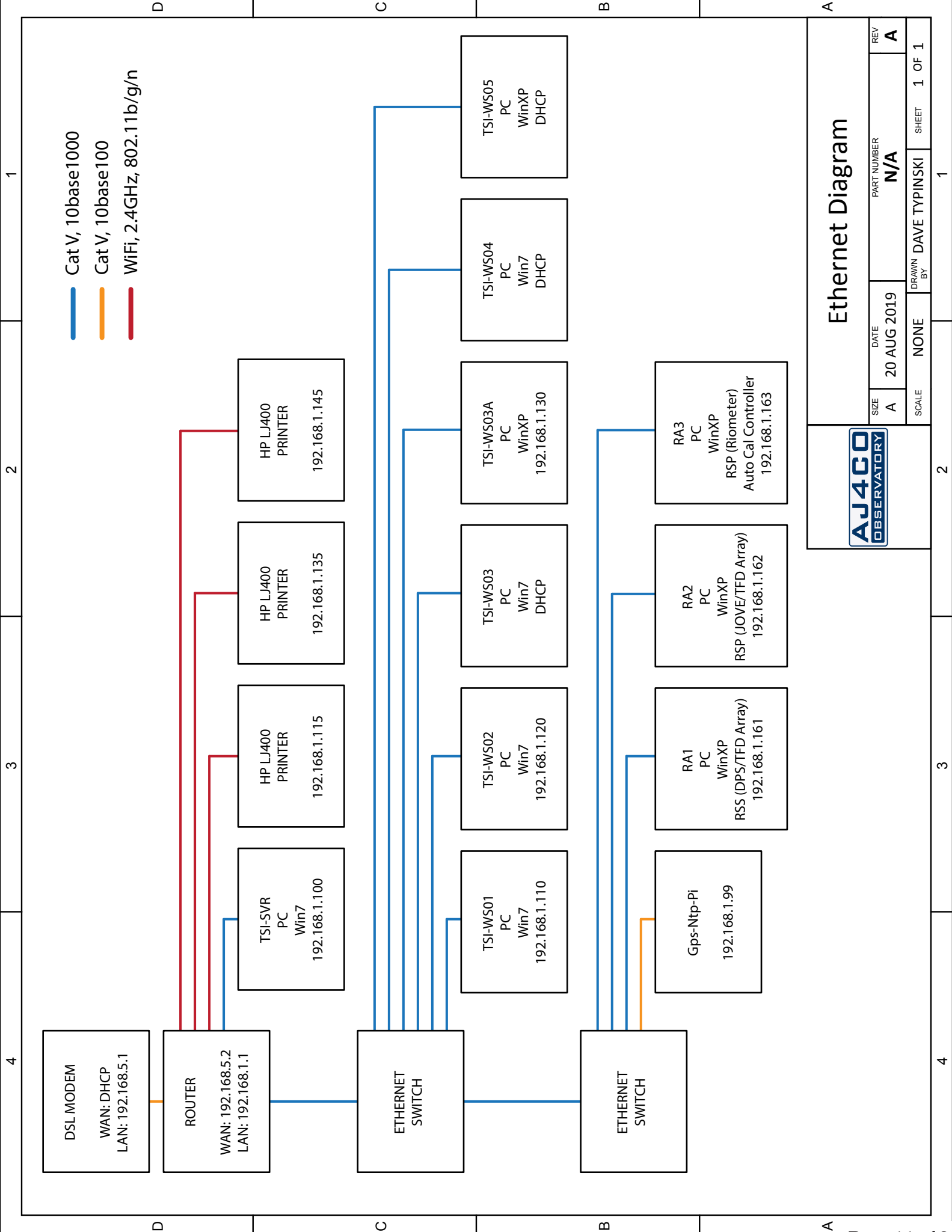

Ethernet Diagram



SIZE	DATE	PART NUMBER	REV
A	20 AUG 2019	N/A	A
SCALE	DRAWN BY	SHEET	1 OF 1
NONE	DAVE TYPINSKI		

TFD Array Beam Steering

Time Delay Cable VoP: 66% ray elements N-S baseline spacing (feet): 32
Array elements E-W baseline spacing (feet): 32

N-S Offset (degrees)	E-W Offset (degrees)	A (S) / B (N)	C (S) / D (N)	E	F (W) / G (E)	H	AZ (degrees)	EL (degrees)
20 N	60 E	7' 2-3/4"	14' 5-1/4"	3' 7-1/4"	18' 3-1/2"	9' 1-3/4"	78	29
20 N	45 E	7' 2-3/4"	14' 5-1/4"	3' 7-1/4"	14' 11-1/4"	7' 5-1/2"	70	43
20 N	30 E	7' 2-3/4"	14' 5-1/4"	3' 7-1/4"	10' 6-3/4"	5' 3-1/4"	58	56
20 N	15 E	7' 2-3/4"	14' 5-1/4"	3' 7-1/4"	5' 5-1/2"	2' 8-3/4"	36	66
20 N	0	7' 2-3/4"	14' 5-1/4"	3' 7-1/4"	0"	0"	0	70
20 N	15 W	7' 2-3/4"	14' 5-1/4"	3' 7-1/4"	5' 5-1/2"	2' 8-3/4"	324	66
20 N	30 W	7' 2-3/4"	14' 5-1/4"	3' 7-1/4"	10' 6-3/4"	5' 3-1/4"	302	56
20 N	45 W	7' 2-3/4"	14' 5-1/4"	3' 7-1/4"	14' 11-1/4"	7' 5-1/2"	290	43
20 N	60 W	7' 2-3/4"	14' 5-1/4"	3' 7-1/4"	18' 3-1/2"	9' 1-3/4"	282	29
15 N	60 E	5' 5-1/2"	10' 11-1/4"	2' 8-3/4"	18' 3-1/2"	9' 1-3/4"	81	30
15 N	45 E	5' 5-1/2"	10' 11-1/4"	2' 8-3/4"	14' 11-1/4"	7' 5-1/2"	75	44
15 N	30 E	5' 5-1/2"	10' 11-1/4"	2' 8-3/4"	10' 6-3/4"	5' 3-1/4"	65	58
15 N	15 E	5' 5-1/2"	10' 11-1/4"	2' 8-3/4"	5' 5-1/2"	2' 8-3/4"	45	69
15 N	0	5' 5-1/2"	10' 11-1/4"	2' 8-3/4"	0"	0"	360	75
15 N	15 W	5' 5-1/2"	10' 11-1/4"	2' 8-3/4"	5' 5-1/2"	2' 8-3/4"	315	69
15 N	30 W	5' 5-1/2"	10' 11-1/4"	2' 8-3/4"	10' 6-3/4"	5' 3-1/4"	295	58
15 N	45 W	5' 5-1/2"	10' 11-1/4"	2' 8-3/4"	14' 11-1/4"	7' 5-1/2"	285	44
15 N	60 W	5' 5-1/2"	10' 11-1/4"	2' 8-3/4"	18' 3-1/2"	9' 1-3/4"	279	30
10 N	60 E	3' 8"	7' 4"	1' 10"	18' 3-1/2"	9' 1-3/4"	84	30
10 N	45 E	3' 8"	7' 4"	1' 10"	14' 11-1/4"	7' 5-1/2"	80	45
10 N	30 E	3' 8"	7' 4"	1' 10"	10' 6-3/4"	5' 3-1/4"	73	59
10 N	15 E	3' 8"	7' 4"	1' 10"	5' 5-1/2"	2' 8-3/4"	57	72
10 N	0	3' 8"	7' 4"	1' 10"	0"	0"	360	80
10 N	15 W	3' 8"	7' 4"	1' 10"	5' 5-1/2"	2' 8-3/4"	303	72
10 N	30 W	3' 8"	7' 4"	1' 10"	10' 6-3/4"	5' 3-1/4"	287	59
10 N	45 W	3' 8"	7' 4"	1' 10"	14' 11-1/4"	7' 5-1/2"	280	45
10 N	60 W	3' 8"	7' 4"	1' 10"	18' 3-1/2"	9' 1-3/4"	276	30

TFD Array Beam Steering

SIZE: A DATE: 01 OCT 2014 PART NUMBER: N/A REV: A
 SCALE: NONE DRAWN BY: DAVE TYPINSKI SHEET: 1 OF 6

TFD Array Beam Steering

Time Delay Cable VoP: 66% **Array elements N-S baseline spacing (feet):** 32
Array elements E-W baseline spacing (feet): 32

N-S Offset (degrees)	E-W Offset (degrees)	A (S) / B (N) C (S) / D (N)	E	F (W) / G (E)	H	AZ (degrees)	EL (degrees)
5 N	60 E	1' 10"	3' 8-1/4"	11"	18' 3-1/2"	9' 1-3/4"	30
5 N	45 E	1' 10"	3' 8-1/4"	11"	14' 11-1/4"	7' 5-1/2"	45
5 N	30 E	1' 10"	3' 8-1/4"	11"	10' 6-3/4"	5' 3-1/4"	60
5 N	15 E	1' 10"	3' 8-1/4"	11"	5' 5-1/2"	2' 8-3/4"	74
5 N	0	1' 10"	3' 8-1/4"	11"	0"	0"	85
5 N	15 W	1' 10"	3' 8-1/4"	11"	5' 5-1/2"	2' 8-3/4"	74
5 N	30 W	1' 10"	3' 8-1/4"	11"	10' 6-3/4"	5' 3-1/4"	60
5 N	45 W	1' 10"	3' 8-1/4"	11"	14' 11-1/4"	7' 5-1/2"	45
5 N	60 W	1' 10"	3' 8-1/4"	11"	18' 3-1/2"	9' 1-3/4"	30
0	60 E	0"	0"	0"	18' 3-1/2"	9' 1-3/4"	30
0	45 E	0"	0"	0"	14' 11-1/4"	7' 5-1/2"	45
0	30 E	0"	0"	0"	10' 6-3/4"	5' 3-1/4"	60
0	15 E	0"	0"	0"	5' 5-1/2"	2' 8-3/4"	75
0	0	0"	0"	0"	0"	0"	90
0	15 W	0"	0"	0"	5' 5-1/2"	2' 8-3/4"	75
0	30 W	0"	0"	0"	10' 6-3/4"	5' 3-1/4"	60
0	45 W	0"	0"	0"	14' 11-1/4"	7' 5-1/2"	45
0	60 W	0"	0"	0"	18' 3-1/2"	9' 1-3/4"	30
5 S	60 E	1' 10"	3' 8-1/4"	11"	18' 3-1/2"	9' 1-3/4"	30
5 S	45 E	1' 10"	3' 8-1/4"	11"	14' 11-1/4"	7' 5-1/2"	45
5 S	30 E	1' 10"	3' 8-1/4"	11"	10' 6-3/4"	5' 3-1/4"	60
5 S	15 E	1' 10"	3' 8-1/4"	11"	5' 5-1/2"	2' 8-3/4"	74
5 S	0	1' 10"	3' 8-1/4"	11"	0"	0"	85
5 S	15 W	1' 10"	3' 8-1/4"	11"	5' 5-1/2"	2' 8-3/4"	74
5 S	30 W	1' 10"	3' 8-1/4"	11"	10' 6-3/4"	5' 3-1/4"	60
5 S	45 W	1' 10"	3' 8-1/4"	11"	14' 11-1/4"	7' 5-1/2"	45
5 S	60 W	1' 10"	3' 8-1/4"	11"	18' 3-1/2"	9' 1-3/4"	30

TFD Array Beam Steering

SIZE	DATE	PART NUMBER	REV
A	01 OCT 2014	N/A	A
SCALE	DRAWN BY	SHEET	2 OF 6
NONE	DAVE TYPINSKI		

TFD Array Beam Steering

Time Delay Cable VoP: 66% **Array elements N-S baseline spacing (feet):** 32
Array elements E-W baseline spacing (feet): 32

N-S Offset (degrees)	E-W Offset (degrees)	A (S) / B (N)	C (S) / D (N)	E	F (W) / G (E)	H	AZ (degrees)	EL (degrees)
10 S	60 E	3' 8"	7' 4"	1' 10"	18' 3-1/2"	9' 1-3/4"	96	30
10 S	45 E	3' 8"	7' 4"	1' 10"	14' 11-1/4"	7' 5-1/2"	100	45
10 S	30 E	3' 8"	7' 4"	1' 10"	10' 6-3/4"	5' 3-1/4"	107	59
10 S	15 E	3' 8"	7' 4"	1' 10"	5' 5-1/2"	2' 8-3/4"	123	72
10 S	0	3' 8"	7' 4"	1' 10"	0"	0"	180	80
10 S	15 W	3' 8"	7' 4"	1' 10"	5' 5-1/2"	2' 8-3/4"	237	72
10 S	30 W	3' 8"	7' 4"	1' 10"	10' 6-3/4"	5' 3-1/4"	253	59
10 S	45 W	3' 8"	7' 4"	1' 10"	14' 11-1/4"	7' 5-1/2"	260	45
10 S	60 W	3' 8"	7' 4"	1' 10"	18' 3-1/2"	9' 1-3/4"	264	30
15 S	60 E	5' 5-1/2"	10' 11-1/4"	2' 8-3/4"	18' 3-1/2"	9' 1-3/4"	99	30
15 S	45 E	5' 5-1/2"	10' 11-1/4"	2' 8-3/4"	14' 11-1/4"	7' 5-1/2"	105	44
15 S	30 E	5' 5-1/2"	10' 11-1/4"	2' 8-3/4"	10' 6-3/4"	5' 3-1/4"	115	58
15 S	15 E	5' 5-1/2"	10' 11-1/4"	2' 8-3/4"	5' 5-1/2"	2' 8-3/4"	135	69
15 S	0	5' 5-1/2"	10' 11-1/4"	2' 8-3/4"	0"	0"	180	75
15 S	15 W	5' 5-1/2"	10' 11-1/4"	2' 8-3/4"	5' 5-1/2"	2' 8-3/4"	225	69
15 S	30 W	5' 5-1/2"	10' 11-1/4"	2' 8-3/4"	10' 6-3/4"	5' 3-1/4"	245	58
15 S	45 W	5' 5-1/2"	10' 11-1/4"	2' 8-3/4"	14' 11-1/4"	7' 5-1/2"	255	44
15 S	60 W	5' 5-1/2"	10' 11-1/4"	2' 8-3/4"	18' 3-1/2"	9' 1-3/4"	261	30
20 S	60 E	7' 2-3/4"	14' 5-1/4"	3' 7-1/4"	18' 3-1/2"	9' 1-3/4"	102	29
20 S	45 E	7' 2-3/4"	14' 5-1/4"	3' 7-1/4"	14' 11-1/4"	7' 5-1/2"	110	43
20 S	30 E	7' 2-3/4"	14' 5-1/4"	3' 7-1/4"	10' 6-3/4"	5' 3-1/4"	122	56
20 S	15 E	7' 2-3/4"	14' 5-1/4"	3' 7-1/4"	5' 5-1/2"	2' 8-3/4"	144	66
20 S	0	7' 2-3/4"	14' 5-1/4"	3' 7-1/4"	0"	0"	180	70
20 S	15 W	7' 2-3/4"	14' 5-1/4"	3' 7-1/4"	5' 5-1/2"	2' 8-3/4"	216	66
20 S	30 W	7' 2-3/4"	14' 5-1/4"	3' 7-1/4"	10' 6-3/4"	5' 3-1/4"	238	56
20 S	45 W	7' 2-3/4"	14' 5-1/4"	3' 7-1/4"	14' 11-1/4"	7' 5-1/2"	250	43
20 S	60 W	7' 2-3/4"	14' 5-1/4"	3' 7-1/4"	18' 3-1/2"	9' 1-3/4"	258	29

TFD Array Beam Steering

SIZE	A	DATE	01 OCT 2014	PART NUMBER	N/A	REV	A
SCALE	NONE	DRAWN BY	DAVE TYPINSKI	SHEET	3 OF 6		

TFD Array Beam Steering											
Time Delay Cable VoP:		66%		Array elements N-S baseline spacing (feet):		32		Array elements E-W baseline spacing (feet):		32	
N-S Offset (degrees)	E-W Offset (degrees)	A (S) / B (N)	C (S) / D (N)	E	F (W) / G (E)	H	AZ (degrees)	EL (degrees)			
25 S	60 E	8' 11"	17' 10-1/4"	4' 5-1/2"	18' 3-1/2"	9' 1-3/4"	105	29			
25 S	45 E	8' 11"	17' 10-1/4"	4' 5-1/2"	14' 11-1/4"	7' 5-1/2"	115	42			
25 S	30 E	8' 11"	17' 10-1/4"	4' 5-1/2"	10' 6-3/4"	5' 3-1/4"	129	53			
25 S	15 E	8' 11"	17' 10-1/4"	4' 5-1/2"	5' 5-1/2"	2' 8-3/4"	150	62			
25 S	0	8' 11"	17' 10-1/4"	4' 5-1/2"	0"	0"	180	65			
25 S	15 W	8' 11"	17' 10-1/4"	4' 5-1/2"	5' 5-1/2"	2' 8-3/4"	210	62			
25 S	30 W	8' 11"	17' 10-1/4"	4' 5-1/2"	10' 6-3/4"	5' 3-1/4"	231	53			
25 S	45 W	8' 11"	17' 10-1/4"	4' 5-1/2"	14' 11-1/4"	7' 5-1/2"	245	42			
25 S	60 W	8' 11"	17' 10-1/4"	4' 5-1/2"	18' 3-1/2"	9' 1-3/4"	255	29			
30 S	60 E	10' 6-3/4"	21' 1-1/2"	5' 3-1/4"	18' 3-1/2"	9' 1-3/4"	108	29			
30 S	45 E	10' 6-3/4"	21' 1-1/2"	5' 3-1/4"	14' 11-1/4"	7' 5-1/2"	120	41			
30 S	30 E	10' 6-3/4"	21' 1-1/2"	5' 3-1/4"	10' 6-3/4"	5' 3-1/4"	135	51			
30 S	15 E	10' 6-3/4"	21' 1-1/2"	5' 3-1/4"	5' 5-1/2"	2' 8-3/4"	155	58			
30 S	0	10' 6-3/4"	21' 1-1/2"	5' 3-1/4"	0"	0"	180	60			
30 S	15 W	10' 6-3/4"	21' 1-1/2"	5' 3-1/4"	5' 5-1/2"	2' 8-3/4"	205	58			
30 S	30 W	10' 6-3/4"	21' 1-1/2"	5' 3-1/4"	10' 6-3/4"	5' 3-1/4"	225	51			
30 S	45 W	10' 6-3/4"	21' 1-1/2"	5' 3-1/4"	14' 11-1/4"	7' 5-1/2"	240	41			
30 S	60 W	10' 6-3/4"	21' 1-1/2"	5' 3-1/4"	18' 3-1/2"	9' 1-3/4"	252	29			
35 S	60 E	12' 1-1/4"	24' 2-3/4"	6' 0-3/4"	18' 3-1/2"	9' 1-3/4"	112	28			
35 S	45 E	12' 1-1/4"	24' 2-3/4"	6' 0-3/4"	14' 11-1/4"	7' 5-1/2"	125	39			
35 S	30 E	12' 1-1/4"	24' 2-3/4"	6' 0-3/4"	10' 6-3/4"	5' 3-1/4"	140	48			
35 S	15 E	12' 1-1/4"	24' 2-3/4"	6' 0-3/4"	5' 5-1/2"	2' 8-3/4"	159	53			
35 S	0	12' 1-1/4"	24' 2-3/4"	6' 0-3/4"	0"	0"	180	55			
35 S	15 W	12' 1-1/4"	24' 2-3/4"	6' 0-3/4"	5' 5-1/2"	2' 8-3/4"	201	53			
35 S	30 W	12' 1-1/4"	24' 2-3/4"	6' 0-3/4"	10' 6-3/4"	5' 3-1/4"	220	48			
35 S	45 W	12' 1-1/4"	24' 2-3/4"	6' 0-3/4"	14' 11-1/4"	7' 5-1/2"	235	39			
35 S	60 W	12' 1-1/4"	24' 2-3/4"	6' 0-3/4"	18' 3-1/2"	9' 1-3/4"	248	28			



TFD Array Beam Steering

SIZE	DATE	PART NUMBER	REV
A	01 OCT 2014	N/A	A
SCALE	NONE	DRAWN BY	SHEET
		DAVE TYPINSKI	4 OF 6

TFD Array Beam Steering

Time Delay Cable VoP: 66% **Array elements N-S baseline spacing (feet):** 32
Array elements E-W baseline spacing (feet): 32

N-S Offset (degrees)	E-W Offset (degrees)	Delay Cable Lengths (feet & inches)				AZ (degrees)	EL (degrees)	
		A (S) / B (N)	C (S) / D (N)	E	F (W) / G (E)			H
40 S	60 E	13' 7"	27' 1-3/4"	6' 9-1/2"	18' 3-1/2"	9' 1-3/4"	116	27
40 S	45 E	13' 7"	27' 1-3/4"	6' 9-1/2"	14' 11-1/4"	7' 5-1/2"	130	37
40 S	30 E	13' 7"	27' 1-3/4"	6' 9-1/2"	10' 6-3/4"	5' 3-1/4"	145	44
40 S	15 E	13' 7"	27' 1-3/4"	6' 9-1/2"	5' 5-1/2"	2' 8-3/4"	162	49
40 S	0	13' 7"	27' 1-3/4"	6' 9-1/2"	0"	0"	180	50
40 S	15 W	13' 7"	27' 1-3/4"	6' 9-1/2"	5' 5-1/2"	2' 8-3/4"	198	49
40 S	30 W	13' 7"	27' 1-3/4"	6' 9-1/2"	10' 6-3/4"	5' 3-1/4"	215	44
40 S	45 W	13' 7"	27' 1-3/4"	6' 9-1/2"	14' 11-1/4"	7' 5-1/2"	230	37
40 S	60 W	13' 7"	27' 1-3/4"	6' 9-1/2"	18' 3-1/2"	9' 1-3/4"	244	27
45 S	60 E	14' 11-1/4"	29' 10-1/2"	7' 5-1/2"	18' 3-1/2"	9' 1-3/4"	120	27
45 S	45 E	14' 11-1/4"	29' 10-1/2"	7' 5-1/2"	14' 11-1/4"	7' 5-1/2"	135	35
45 S	30 E	14' 11-1/4"	29' 10-1/2"	7' 5-1/2"	10' 6-3/4"	5' 3-1/4"	150	41
45 S	15 E	14' 11-1/4"	29' 10-1/2"	7' 5-1/2"	5' 5-1/2"	2' 8-3/4"	165	44
45 S	0	14' 11-1/4"	29' 10-1/2"	7' 5-1/2"	0"	0"	180	45
45 S	15 W	14' 11-1/4"	29' 10-1/2"	7' 5-1/2"	5' 5-1/2"	2' 8-3/4"	195	44
45 S	30 W	14' 11-1/4"	29' 10-1/2"	7' 5-1/2"	10' 6-3/4"	5' 3-1/4"	210	41
45 S	45 W	14' 11-1/4"	29' 10-1/2"	7' 5-1/2"	14' 11-1/4"	7' 5-1/2"	225	35
45 S	60 W	14' 11-1/4"	29' 10-1/2"	7' 5-1/2"	18' 3-1/2"	9' 1-3/4"	240	27
50 S	60 E	16' 2-1/4"	32' 4-1/4"	8' 1"	18' 3-1/2"	9' 1-3/4"	125	25
50 S	45 E	16' 2-1/4"	32' 4-1/4"	8' 1"	14' 11-1/4"	7' 5-1/2"	140	33
50 S	30 E	16' 2-1/4"	32' 4-1/4"	8' 1"	10' 6-3/4"	5' 3-1/4"	154	37
50 S	15 E	16' 2-1/4"	32' 4-1/4"	8' 1"	5' 5-1/2"	2' 8-3/4"	167	39
50 S	0	16' 2-1/4"	32' 4-1/4"	8' 1"	0"	0"	180	40
50 S	15 W	16' 2-1/4"	32' 4-1/4"	8' 1"	5' 5-1/2"	2' 8-3/4"	193	39
50 S	30 W	16' 2-1/4"	32' 4-1/4"	8' 1"	10' 6-3/4"	5' 3-1/4"	206	37
50 S	45 W	16' 2-1/4"	32' 4-1/4"	8' 1"	14' 11-1/4"	7' 5-1/2"	220	33
50 S	60 W	16' 2-1/4"	32' 4-1/4"	8' 1"	18' 3-1/2"	9' 1-3/4"	235	25

TFD Array Beam Steering

SIZE	DATE	PART NUMBER	REV
A	01 OCT 2014	N/A	A
SCALE	NONE	DRAWN BY	SHEET
		DAVE TYPINSKI	5 OF 6

TFD Array Beam Steering

Time Delay Cable VoP: 66% **Array elements N-S baseline spacing (feet): 32**
Array elements E-W baseline spacing (feet): 32

N-S Offset (degrees)	E-W Offset (degrees)	Delay Cable Lengths (feet & inches)				AZ (degrees)	EL (degrees)	
		A (S) / B (N)	C (S) / D (N)	E	F (W) / G (E)			H
55 S	60 E	17' 3-1/2"	34' 7-1/4"	8' 7-3/4"	18' 3-1/2"	9' 1-3/4"	130	24
55 S	45 E	17' 3-1/2"	34' 7-1/4"	8' 7-3/4"	14' 11-1/4"	7' 5-1/2"	145	30
55 S	30 E	17' 3-1/2"	34' 7-1/4"	8' 7-3/4"	10' 6-3/4"	5' 3-1/4"	158	33
55 S	15 E	17' 3-1/2"	34' 7-1/4"	8' 7-3/4"	5' 5-1/2"	2' 8-3/4"	169	35
55 S	0	17' 3-1/2"	34' 7-1/4"	8' 7-3/4"	0"	0"	180	35
55 S	15 W	17' 3-1/2"	34' 7-1/4"	8' 7-3/4"	5' 5-1/2"	2' 8-3/4"	191	35
55 S	30 W	17' 3-1/2"	34' 7-1/4"	8' 7-3/4"	10' 6-3/4"	5' 3-1/4"	202	33
55 S	45 W	17' 3-1/2"	34' 7-1/4"	8' 7-3/4"	14' 11-1/4"	7' 5-1/2"	215	30
55 S	60 W	17' 3-1/2"	34' 7-1/4"	8' 7-3/4"	18' 3-1/2"	9' 1-3/4"	230	24
60 S	60 E	18' 3-1/2"	36' 7"	9' 1-3/4"	18' 3-1/2"	9' 1-3/4"	135	22
60 S	45 E	18' 3-1/2"	36' 7"	9' 1-3/4"	14' 11-1/4"	7' 5-1/2"	150	27
60 S	30 E	18' 3-1/2"	36' 7"	9' 1-3/4"	10' 6-3/4"	5' 3-1/4"	162	29
60 S	15 E	18' 3-1/2"	36' 7"	9' 1-3/4"	5' 5-1/2"	2' 8-3/4"	171	30
60 S	0	18' 3-1/2"	36' 7"	9' 1-3/4"	0"	0"	180	30
60 S	15 W	18' 3-1/2"	36' 7"	9' 1-3/4"	5' 5-1/2"	2' 8-3/4"	189	30
60 S	30 W	18' 3-1/2"	36' 7"	9' 1-3/4"	10' 6-3/4"	5' 3-1/4"	198	29
60 S	45 W	18' 3-1/2"	36' 7"	9' 1-3/4"	14' 11-1/4"	7' 5-1/2"	210	27
60 S	60 W	18' 3-1/2"	36' 7"	9' 1-3/4"	18' 3-1/2"	9' 1-3/4"	225	22



TFD Array Beam Steering

SIZE	A	DATE	01 OCT 2014	PART NUMBER	N/A	REV	A
SCALE	NONE	DRAWN BY	DAVE TYPINSKI	SHEET	6 OF 6		

Find the magnetic declination at your location

Sites of Interest

- [Cosmos Plus!](#)
- [Live Meteors](#)
- [Satellite tracking](#)
- [Radio Astronomy](#)

Find your location

City

Enter your city...

Country

USA

State

Search map

[Browse countries](#)

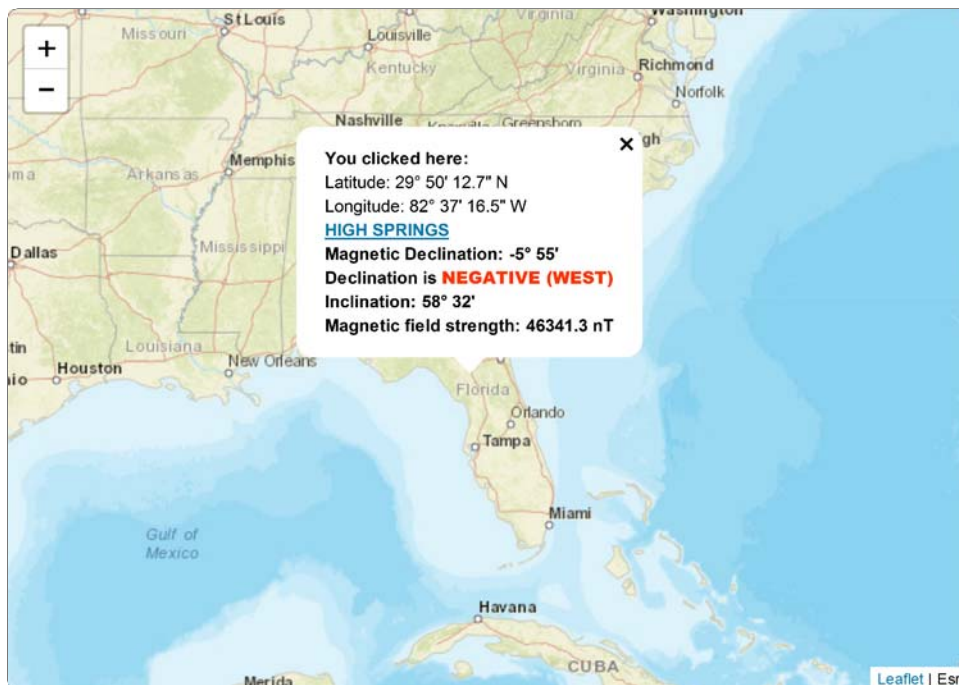

[Share](#)

Copyright ©2020 Magnetic-Declination.com

Magnetic declination is calculated using the World Magnetic Model WMM2020.

Questions? webmaster@magnetic-declination.com

...If the compass at your place is pointing **clockwise** with respect to the True North, declination is **positive** or **EAST**

If the compass at your place is pointing **counter-clockwise** with respect to the True North, declination is **negative** or **WEST**

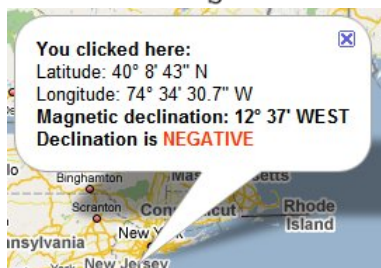
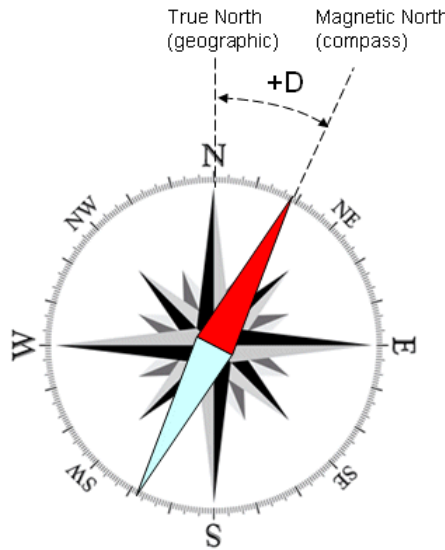
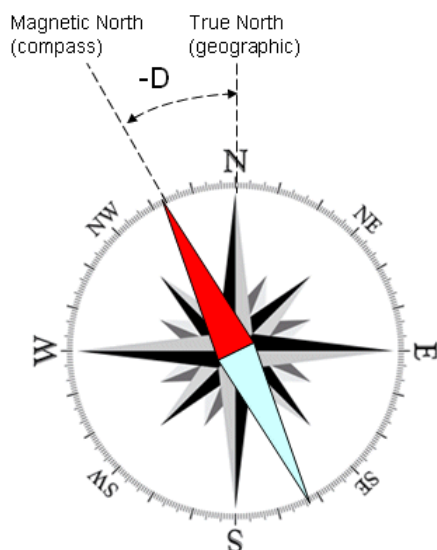

Negative declination (WEST)

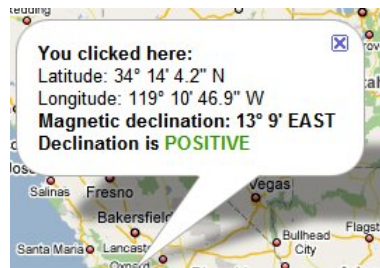

Positive declination (EAST)

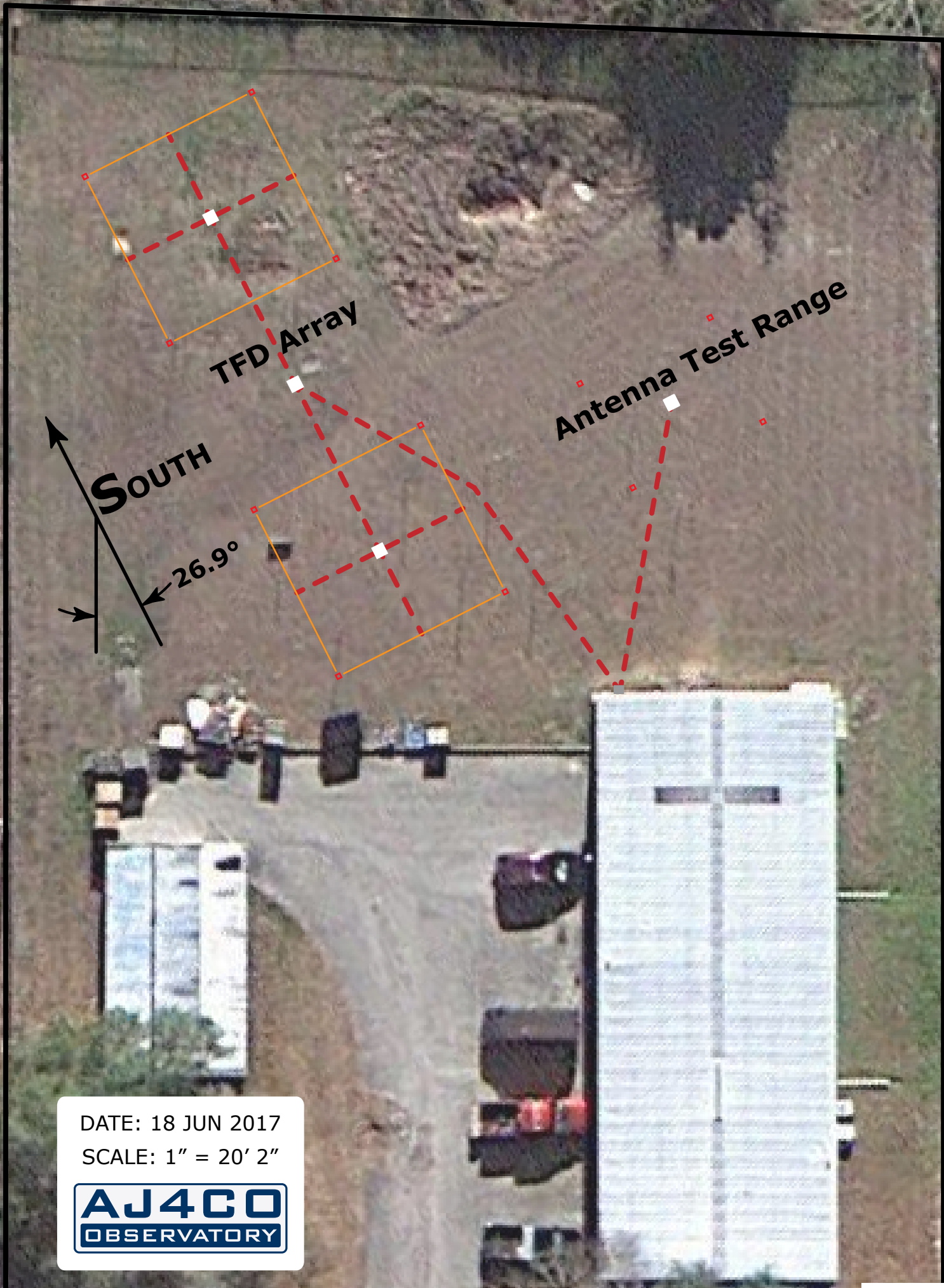

TFD Array

Antenna Test Range

SOUTH

26.9°

DATE: 18 JUN 2017
SCALE: 1" = 20' 2"



UFRO

AJ400
OBSERVATORY

LGM

